

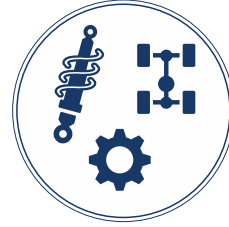

MATERIAL TESTING



COMPONENT  
& ASSEMBLY TESTING



ROAD TESTING, EMISSION TESTING &  
ENGINE/POWERTRAIN TESTING

# **BOSMAL** Research & development

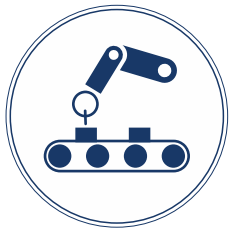

PROTOTYPING, MANUFACTURING,  
ENGINEERING  
& PRODUCTION AUTOMATION



ENGINEERING  
SERVICES



HOMOLOGATION  
TYPE APPROVAL

- The headquarter: Poland, Bielsko-Biała
- Subsidiary: BOSMAL Italia s.r.l. s.u. – Italy, Torino
- Customer representation: Germany, Sigmaringen
- BOSMAL Branch/ Customer site – Płock
- BOSMAL Customer site / temporary Customer site
- BOSMAL temporary test site – Italy, Spain, Sweden, Ukraine and other European countries

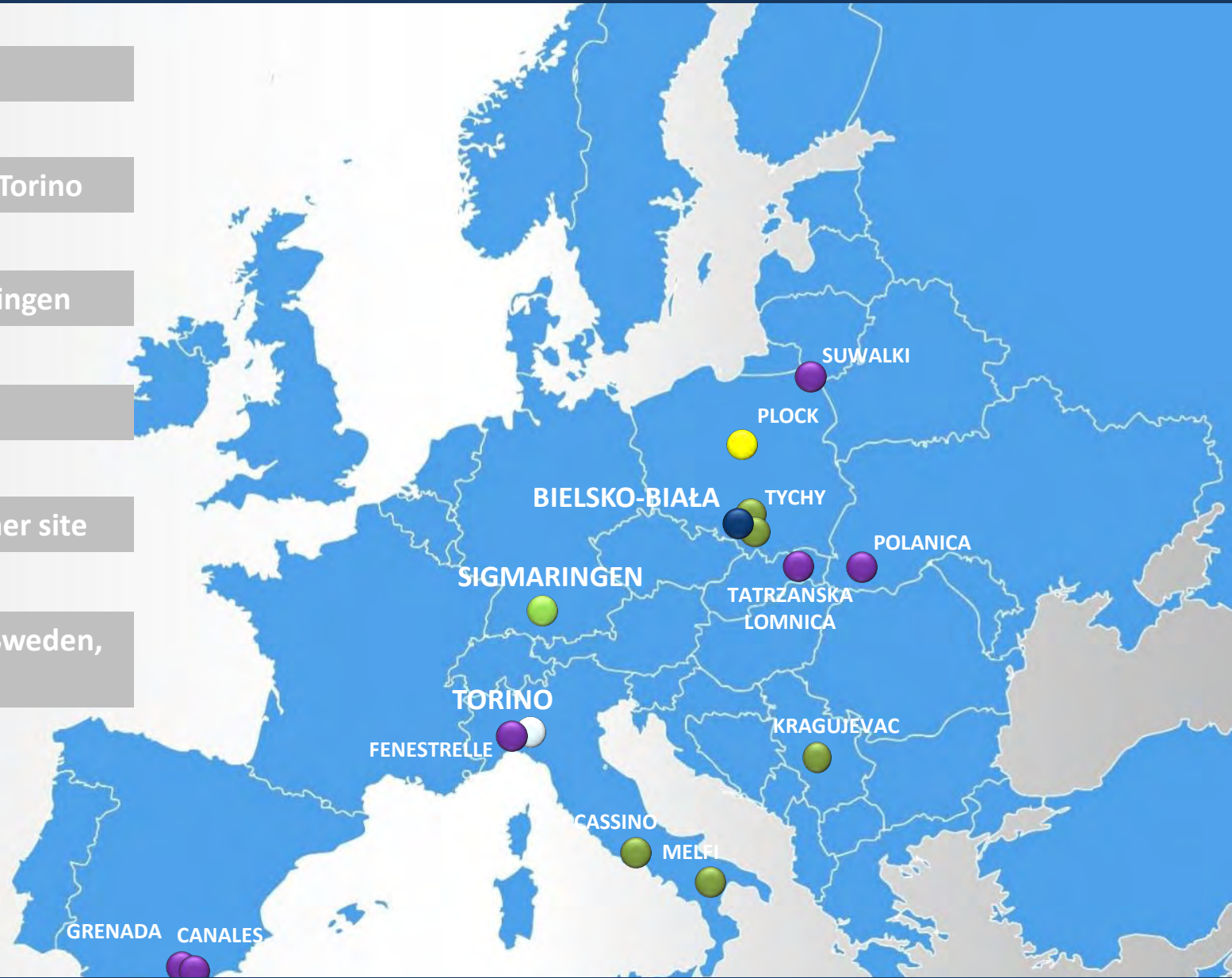

# BOSMAL RESEARCH & DEVELOPMENT

- Research and Development Center (with that legal status)
- Research laboratory meeting the requirements of PN-EN ISO / IEC 17025: 2018-02 - with a wide range of accreditation (over 600 methodologies)
- License for approval tests of vehicles (internal combustion and electric), as well as their equipment or parts (including internal combustion engines, electric engines and batteries)
- Certified, integrated management system (PN-EN ISO 9001:2015-10, PN-ISO 45001:2018-06 and PN-EN ISO 14001:2015-09)
- Certificate AQAP 2110:2016 - confirming compliance with NATO quality requirements in design, development and manufacture
- License of the Ministry of Interior and Administration No. B-138/2023 to conduct business activities in the field of production and trade in explosives, weapons, ammunition and products and technology for military or police purposes
- TISAX label. Results of Institute are available at <https://enx.com/tisax>
- Comprehensive range of research, design and production, engineering and production implementations
- Personnel: 400 employees, including 230 engineers

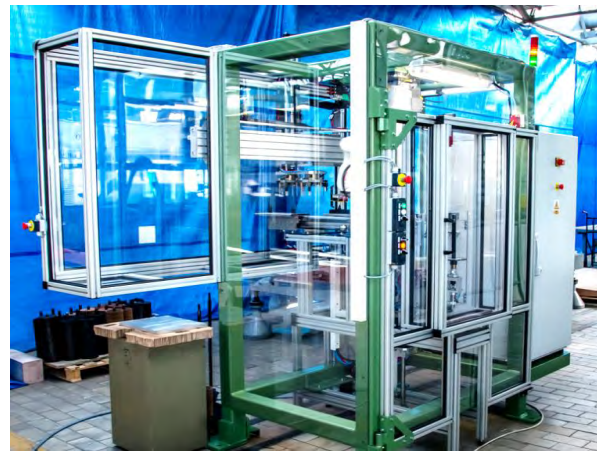

50 years on the automotive market & 25 years as an Accredited Testing Laboratory AB 128

**FIND OUT MORE**  
www







# MATERIAL TESTING

1. material composition analysis (metals, alloys of metals)
2. non-metallic materials constitution and composition analysis (rubber, plastics, solvents, paints, fuels and lubricants)
3. chemical and physicochemical tests
4. galvanized and organic (paints), coatings examination (corrosion tests), thickness, scratch (adhesion) testing
5. material resistance to light and climatic environment (ageing tests)
6. cleanliness of parts and components inclusions and contamination analysis regarding its compositions and constitutions



7. materials VOC (Volatile Organic Compounds) analyses
8. emission testing of hydrocarbons and halocarbons
9. tests of petroleum products: fuels, oils, lubricants, coolants for radiators, brake fluids, anaerobic adhesives, sealing compounds, other materials
10. thermal analysis
11. aging, heat cycles, environmental trials, low and high temperature resistance of materials and components tests



**FIND OUT MORE**  
presentation

50 years on the automotive market & 25 years as an Accredited Testing Laboratory AB 128



**FIND OUT MORE**  
www





## Tests of:

1. engines and exhaust aftertreatment systems
2. transmissions and gearboxes
3. braking systems
4. hydraulic hoses
5. heat exchangers
6. suspension systems
7. windows
8. automotive parts and assemblies
9. chassis and body components

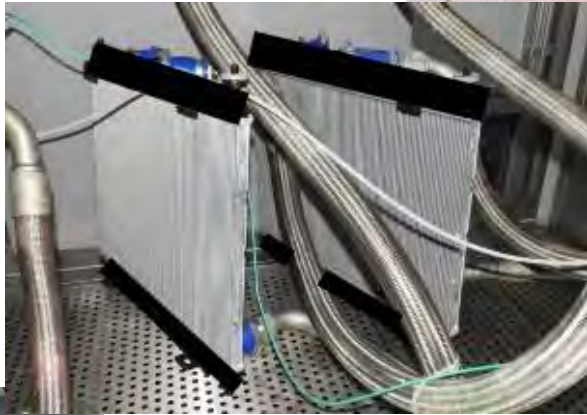

## Vibration system dedicated for EV large battery testing



## Tests:

10. resistance, durability, material, functionality
11. vibration, vibroacoustic (NVH) and tensometric
12. static and dynamic twist tests
13. aging, climatic, temperature, corrosion resistance
14. resistance to water
15. dust resistance
16. pressure
17. thermovision
18. photometric
19. electrotechnical and electronic
20. photobiological safety assessment

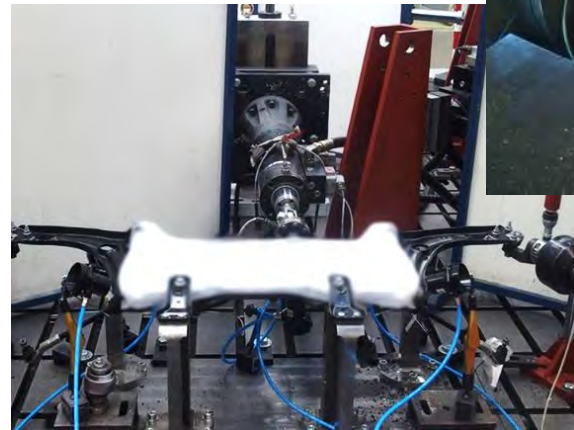

**FIND OUT MORE**  
presentation

**FIND OUT MORE**  
www





# ROAD TESTING, EMISSION TESTING & ENGINE/POWERTRAIN TESTING

2 x Emissions Testing Laboratories (including 4x4 and climatic chamber)

1. road tests
2. hybrid and electric vehicles/parts testing as well as conversion of vehicles from combustion engine to electric drive
3. static tests of vehicles, machines, equipment and parts
4. engine and exhaust aftertreatment system tests
5. exhaust emission and fuel consumption tests: RDE – Real Driving Emissions (PEMS – Portable Emission Measurement System)
6. exhaust emission and fuel consumption tests: at engine test cells (at temperatures of -35°C to 60°C, on various road surfaces, different climate conditions and route profiles
7. dynamic vehicle tests on 2WD and 4WD chassis dynos

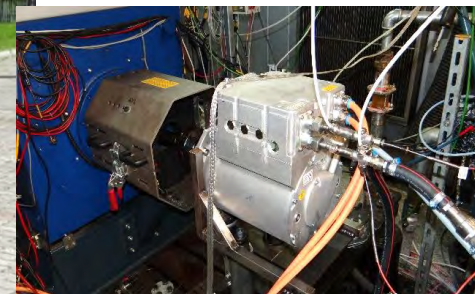
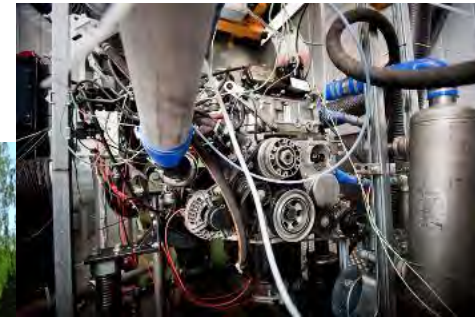

8. vehicles, machinery and devices testing in large chambers at high and low temperature (from -45°C to 75°C or from -35°C to 60°C)
9. vehicle functionality testing
10. engine durability testing
11. engine development testing
12. calibration work
13. testing engine oils and liquids
14. testing for type approval
15. Conformity of Production
16. ISC (In-Service Conformity)
17. MS (Market Surveillance)

**FIND OUT MORE**  
presentation

50 years on the automotive market & 25 years as an Accredited Testing Laboratory AB 128

**FIND OUT MORE**  
www





## Design & Production - turnkey systems

1. development of design assumptions
2. engineering calculations
3. designing
4. modeling
5. prototyping
6. verification and testing
7. certification
8. implementation into production

### Design:

- 3D models
- 2D documentation
- Files format conversion

### Simulation /Calculation analysis:

- Static linear
- Static nonlinear
- Dynamic
- Modal (natural frequency)
- Coupled field

### Unit and small lot production:

- laboratory gauges & equipment
- Holders for vibration tests
- Control and measurement devices
- work center

### Precise machining technologies:

- milling
- turning
- grinding
- WEDM (wire electrical discharge machining)
- CMM validation

### Metrological testing and certification



## Automation and robotization in Industry

1. production automation, special machines, test stands
2. precise production equipment, measuring instruments – design and production
3. technological equipment of production lines
4. workshop aids, mock-ups, prototypes
5. support for maintenance and quality control

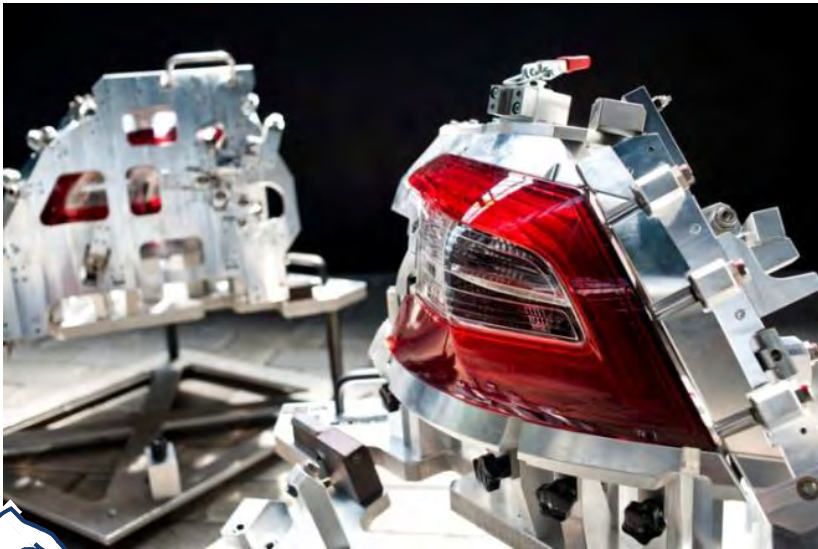

**FIND OUT MORE**  
presentation

**FIND OUT MORE**  
www



## Staff augmentation (Body/ team leasing):

1. Rental of employees (including residents)
2. Auditors/ experts outsourcing
  1. System audits
  2. Product/ service audit
  3. Process audit
  4. Interim Management

## Special production

1. 3D Printing
2. Precision parts
3. Surface coating
4. Parts Machining – technologies
5. Injection Moulding

## Individual design

1. Body Systems
2. Exterior trim systems
3. Interior Trim Systems
4. New Product Development (NPD)
5. Modeling and engineering calculations
6. Draughting and Markup
7. Product analysis and optimization
8. 3D scanning and reverse engineering
9. Assembly design
10. Data Management
11. Materials

## Opinions, analyzes, trainings and workshops

1. Technical analyses and opinions
2. Opinions on innovativeness
3. Root cause analysis (RCA) of non-conformances of components and subassemblies
4. Verifications of the conformity of vehicle production with the producer's requirements,
5. Trainings on type-approval regulations and requirements
6. Workshops on material testing

## Development and optimization of processes in the company

1. Production processes simulation
2. Organization of purchases
3. Implementation and improvement of management systems
4. ERP/CAD/CAM/PLM systems
5. Production planning
6. Organization of the supply chain (logistics and warehouses)
7. Total Productive Maintenance (TPM)
8. Analysis and verification of manufacturing technology
9. Energy audits
10. Analysis and optimization of production and/or management processes



**FIND OUT MORE**  
presentation

**FIND OUT MORE**  
www





# HOMOLOGATION - TYPE APPROVAL

1. EU type approval tests of a vehicle or vehicle type for vehicle categories M, N, O, L, T, R, C and S,
2. type approval tests of equipment or parts for vehicle categories: M, N, O, L, T, R, C and S,
3. type approval tests of the assembly method of the installation adapting a given type of vehicle to run on gaseous fuel, for vehicle categories: M and N;
4. control of conformity of production (COP) of a vehicle, an item of equipment or parts and inspection of the assembly conformity of the installation adapting a given type of vehicle to run on gaseous fuel
5. tests within the scope of national and EU individual vehicle approval for the categories of vehicles: M, N, and O
6. tests within the scope of individual vehicle approval for the categories of vehicles: L, T, R and C

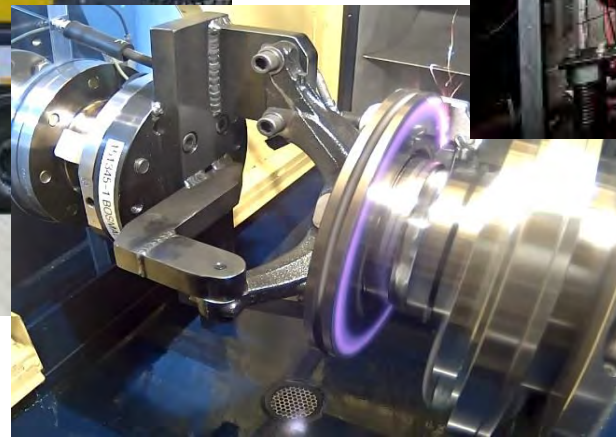

[FIND OUT MORE](#)  
presentation

50 years on the automotive market & 25 years as an Accredited Testing Laboratory AB 128

[FIND OUT MORE](#)  
www



- SCOPE OF ACCREDITATION OF THE TESTING LABORATORY NO. AB 128
- CERTIFICATES, RECOMMENDATIONS, AWARDS AND DISTINCTIONS
- CONTACT – [kam@bosmal.com.pl](mailto:kam@bosmal.com.pl), +48 33 8130 544, +48 33 8130 462



AB 128



SCOPE-ID: ST38TZ  
<https://enx.com/tisax>



4 022 2010 L

## We welcome your business

- MATERIAL TESTING
- COMPONENT & ASSEMBLY TESTING
- ROAD TESTING, EMISSION TESTING & ENGINE/POWERTRAIN TESTING
- PROTOTYPING, MANUFACTURING, ENGINEERING & PRODUCTION AUTOMATION
- HOMOLOGATION - TYPE APPROVAL



RETURN

50 years on the automotive market & 25 years as an Accredited Testing Laboratory AB 128



FIND OUT MORE  
www



**THANK YOU FOR YOUR ATTENTION**



MATERIAL TESTING

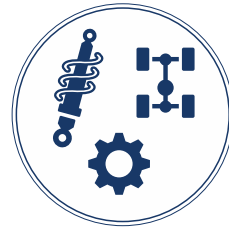

COMPONENT  
& ASSEMBLY TESTING



ROAD TESTING, EMISSION TESTING &  
ENGINE/POWERTRAIN TESTING

**BOSMAL**

**material testing**



PROTOTYPING, MANUFACTURING, ENGINEERING  
& PRODUCTION AUTOMATION



ENGINEERING  
SERVICES



HOMOLOGATION  
TYPE APPROVAL

[RETURN](#)

[SEE MORE](#)

[www](http://www.bosmal.co.uk)

50 years on the automotive market & 25 years as an Accredited Testing Laboratory AB 128





# MATERIAL TESTING

- Material identification
- Chemical composition
- Emissions from materials
- Internal and external cleanliness of products
- Metallographic analyses
- Scanning electron microscopy (SEM)
- Environmental resistance
- Corrosion testing
- Physico-chemical properties
- Component & assembly testing
- Exemplary research equipment
- Accreditation
- Certificates
- Customers' recommendations and accreditations

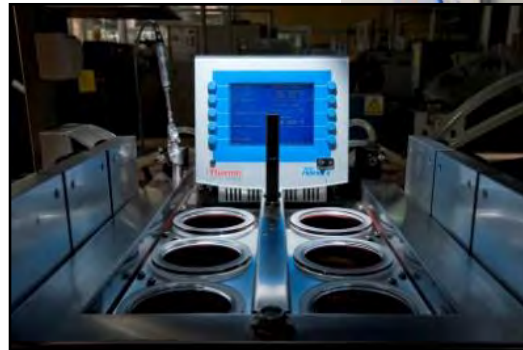

[RETURN](#)

50 years on the automotive market & 25 years as an Accredited Testing Laboratory AB 128



## Materials development:

- support in the development and implementation of new materials, components and composites used in the automotive industry
- material tests, functional and durability tests as well as integration tests of materials and components

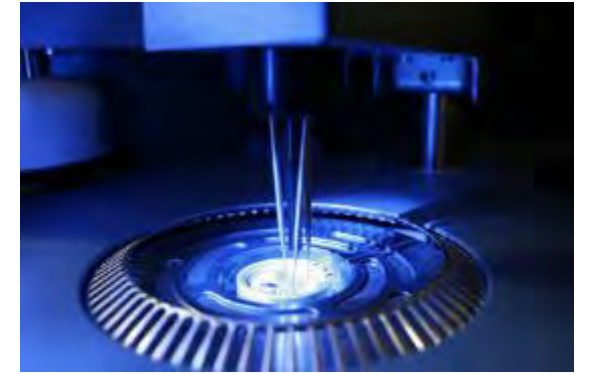
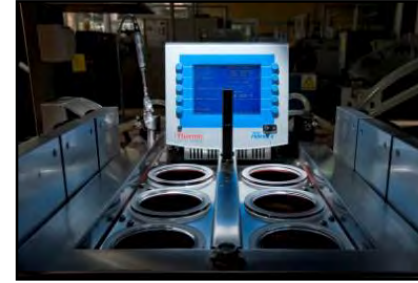

- material composition analysis (metals, alloys of metals)
- non metallic materials constitution and composition analysis (rubber, plastics, solvents, paints, fuels and lubricants)
- chemical and physicochemical tests
- galvanized and organic (paints), coatings examination (corrosion tests), thickness, scratch (adhesion)
- material resistance to light and climatic environment (ageing tests)
- cleanliness of parts and components inclusions and contamination analysis regarding its compositions and constitutions
- materials VOC (Volatile Organic Compounds) analyses
- emission testing of hydrocarbons and halocarbons
- tests of petroleum products: fuels, oils, lubricants, coolants for radiators, brake fluids, anaerobic adhesives, sealing compounds, other materials
- thermal analysis
- tests of ageing, heat cycles, environmental trials, low and high temperature resistance of materials and components



[RETURN](#)





## MATERIAL IDENTIFICATION

**Materials identification** is very important in quality assurance and analysis of failures and their causes.

The knowledge and experience of our staff and the wide, continuously expanding analytical facilities allow identification of: plastic, rubber and petroleum products; metals and their alloys

In case of **metal and their alloys** is usually based on:

- by optical emission spectrometry with inductively coupled plasma (ICP-OES)
- X-ray fluorescence with wavelength dispersion (WD-XRF)

In case of **plastic materials** is usually based on:

- Fourier transformation infrared spectroscopy (FTIR)
- Differential scanning calorimetry (DSC)
- Thermogravimetry (TGA) also with infrared spectroscopy (TGA-FTIR)



[RETURN](#)





We conduct **chemical composition tests** (determining the content of main and trace elements) of different type and sample origin, among others:

- metals, metal alloys and sinters, among others: iron alloys, cast iron, aluminium and aluminium alloys, copper and copper alloys, zinc and zinc alloys, nickel and nickel alloys and others
- dusts, sediments, residues, liquid and solid samples of various origin, water
- petroleum products, including fuels (gasoline, diesel, biodiesel and others), biocomponents, engine oils, transmission oils, lubricants, cooling fluids and others
- plastic, rubber, fabrics, textiles, foams, etc.
- anti-corrosion coatings



[RETURN](#)



We conduct tests of products and materials in terms of **emissions of volatile substances** and **emitted odours**. Organic substances emitted from tested products and materials, after being absorbed on suitable solid adsorbents or directly from the sample are analysed using gas and liquid chromatography methods. Volatile and semi-volatile organic compounds, carbonyl compounds (including aldehydes), phthalates, amines and nitrosamines are quantitatively and qualitatively analysed.

## Examples:

- **Determination of volatile, semi-volatile and heavy organic compounds (VOC, SVOC, FOG) by direct thermal desorption and chromatographic analysis**  
Standards: VDA278, GMW15634 ...
- **Total volatile organic compounds emission (TVOC) and determination of specific substances using a headspace sampler**  
Standards: VDA 277, PV3341, VCS 1027,2749 ....
- **Determination of organic compound emission using a microchamber**  
Standards: ISO 12219-3, TPJLR.52.104 ...



[RETURN](#)



## Examples:

### Determination of formaldehyde and carbonyl compounds emission

Standards: VDA 275, PV3925, VCS 1027,2739....

### Volatile substances emissions in a 1 m3 emission testing chamber

Standards: GS 97014 (-,2,3,4), VDA 276, PV3942, ISO 12219-4 ....

This test method is dedicated for assemblies and large components and allows on-line monitoring of hydrocarbons emission during the test and determination of VOC,SVOC, carbonyl compounds, amines and nitrosoamines by chromatographic analyses (GC-FID/MS, HPLC, GC-NPD) and odor



## Fogging tests

Standards: DIN 75201, SAE J1756, PV3015 ...

These tests consist of condensation of evaporated, volatile components from interior equipment on vehicular window glass, the front windscreen in particular and are also important in case of modern headlights testing.

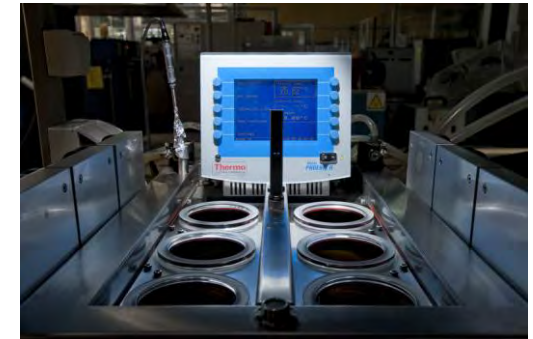

## Odor testing

Standards: VDA 270, PV3900, MS 300-34, TSM 0505G ...

This tests are conducted directly in laboratory glassware by a trained odor panel. Both the intensity of the smell (on a suitable scale), the type of smell (description) and subjective feelings (pleasant, unpleasant) are evaluated.

Additionally, we conduct tests of material and product smell after emission tests in a 1m3 chamber, as well as evaluation of the smell and air quality in vehicle cabins. Samples are collected into inert bags and evaluated using an olfactometer.



[RETURN](#)





**Product cleanliness** testing is a very important element in the quality assessment of many components, especially those having contact with operating fluid. Such tests are carried out in a clean room of ISO 6 cleanliness class (according to ISO 14644).

The basic factors determining the purity of the tested object are: mass of insoluble impurities, mass of soluble impurities, amount of insoluble impurities of a certain size and type of contamination. In the case of insoluble (solid) impurities, it is possible to divide them according to their nature: metallic, non-metallic and fibers, as well as by chemical composition.

The choice of the extraction method depends on the characteristics of the tested object and on the specified properties: internal/external/overall purity.

Extracted pollutants are analyzed by the following methods:

- gravimetric – the mass of contaminants
- microscopic – the quantity and size of the contaminants
- scanning electron microscopy (SEM)– the chemical composition of the impurities
- infrared spectroscopy – the chemical composition of organic impurities

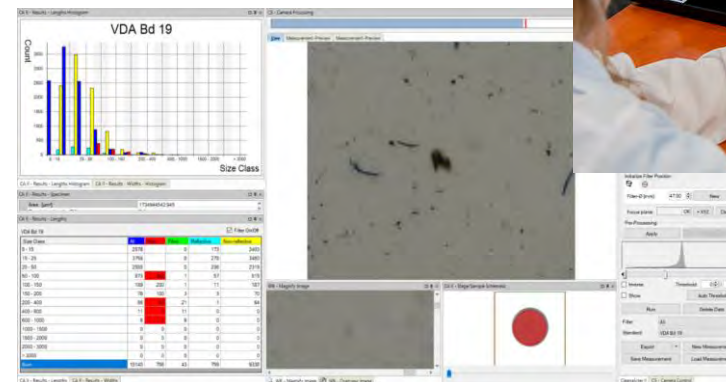



- **Mechanical properties**

Standards: ISO 6892-1, ISO 2739, ISO 8492 ...

- **Non-destructive tests – material discontinuities**

Standards: EN 26157-1, ISO 6157-2 ...

- **Metallographic assessments:**

- Microstructure
- Decarburisation depth
- Grain size
- Graphite distribution
- Layer thickness
- ....

- **Hardness**

Standards: ISO 945-1, ISO 3887, ASTM E45, ASTM E112 ...

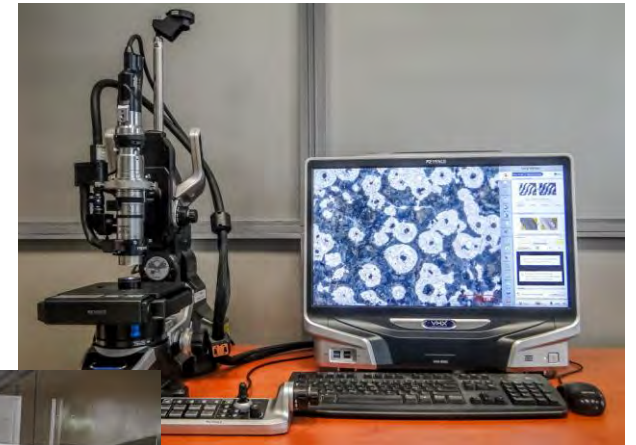

[RETURN](#)





**Scanning electron** microscope with the ability to work in both high and low vacuum mode, which allows analysis of both conductive and nonconductive samples. It has the ability to image SE (secondary electron) and BSE (backscattered electron), it is also equipped with EDS analyzers (energy dispersive X-ray spectroscopy) and EBSD (electron backscatter diffraction) from Bruker.

- Qualitative and quantitative analysis and mapping of elemental composition of samples.
- Evaluation of fractography of the fracture surface to determine the nature of the crack, material discontinuities and, for example, hydrogen embrittlement.
- Analysis of the size and type of non-metallic inclusions.
- Linear microanalysis of coatings and diffusion layers.
- Classification of pollutants on the filters – cleanliness tests.
- Possibility to test samples with larger dimensions (300x200x200 mm) due to the large chamber.

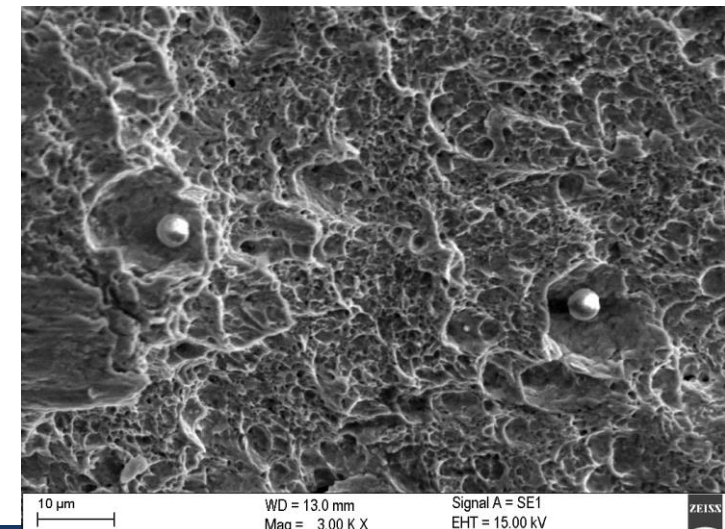





**External conditions** like temperature, humidity or light may have effect on materials properties (mechanical, visual, aesthetic, haptic...). BOSMAL have broad possibilities to check the effect of various conditions on tested materials:

- Temperature: -70 ... 210 oC
- Humidity: 0- 98 %RH also 100 %RH (condensation)

- **Ozone resistance**

A rubber or thermoplastic rubber's resistance to cracking when subjected to static or dynamic stretching strains is assessed in air at a specified temperature, humidity and concentration of ozone, with the direct action of light being eliminated.

The ozone chamber with a working volume of 310 litres also permits tests on non-rubber materials to be carried out, at a wide range of ozone concentrations: from 25 to 1000 pphm.

- Resistance to various fluids and substances (fuels, oils, windshield fluid, hand cream, lotion ...)



[RETURN](#)



## Resistance to weather conditions – Xenon-arc lamps

The test method consists of exposing working samples to artificial weather conditions (filtered xenon lamp, temperature, humidity and precipitation) in order to simulate ageing processes that occur as a result of natural weather conditions, in the laboratory.

Standards: ISO 4892-2 (met. A), ISO 16474-2 (met. A), ISO 105-B04 ...

## Resistance to light

The test method consists of determining the colour fastness and ageing characteristics of the products in response to artificial light simulating natural daylight passing through window glass with the unmistakable action of heat. The working sample of the tested product is subjected to artificial light under defined conditions. Colour fastness is assessed by comparing the colour change of the test specimen to a non-exposed specimen

Standards: ISO 4892-2 (met. B), ISO 16474-2 (met. B), ISO 105-B02 ...

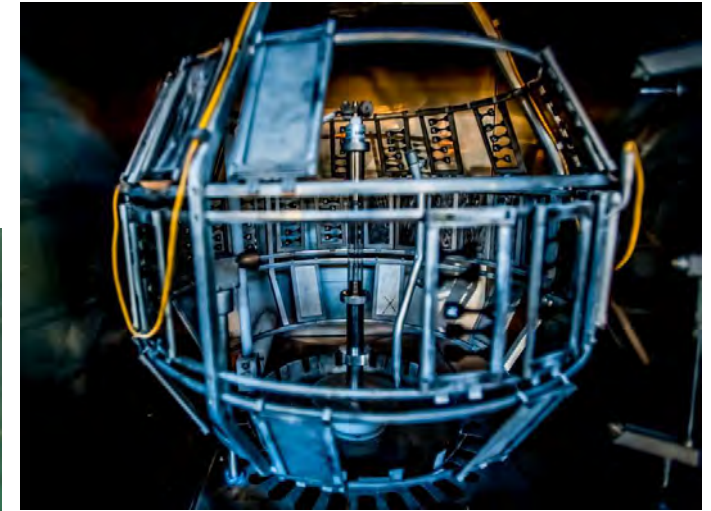

[RETURN](#)





Objects are tested in **artificial corrosive atmospheres** (e.g. salt spray, immersion in corrosive solutions, sulfur dioxide environment, specific climatic conditions, condensation of water vapor, etc).

The surfaces of the objects and their base material are evaluated. Tests can be performed on reference samples (e.g. coated and/or galvanized vehicle body parts) or on finished objects (e.g. LPG tanks, bumpers, wipers, heat exchangers, rocker arms, brackets, covers, etc.). The laboratory also has the ability to test items not related to the automotive industry.

Standards: ASTM B117, ASTM G85, ISO 9227, ISO 6988

So-called **internal corrosion** tests are also performed in the laboratory, where test objects (mainly heat exchangers) are subjected to simulated operation with fluids causing accelerated corrosion, or exhaust gas condensate.





## Noxious Gases Test

The test in flowing mixed gas corrosion test allows to determine the corrosive effect of the working and storage environment on electrotechnical components, especially contacts, terminals and connections (considered both separately and as integrated into a component or assembled as a complete equipment).

Tested samples are placed in the AirEvent Gas/600/0 chamber under various temperature and humidity conditions, in the atmosphere of single corrosive gas or their mixture: Cl<sub>2</sub>, SO<sub>2</sub>, NO<sub>2</sub>, H<sub>2</sub>S

Gases are mixed with together depending on the test method and/or Customer requirements. The working range of gases concentration is from 10 to 500 ppb.

Gases concentration are monitored with the use of SPM Flex analyser

Preferred test duration is 4, 7, 10, 14 or 21 days.

Standards: IEC 60068-2-60, EN 60512-11-14, ASTM B845-97 ...



[RETURN](#)





- **Melting temperature, crystallization, glass transition, degree of crystallinity**
  - Standards: ASTM D3418, ISO 11357 (-1,-2,-3), ASTM E1356 ...
- **Impact testing acc. to Charpy and Izod**
  - Standards: ISO 179-1, ISO 180
- **Flammability - horizontal and vertical**
  - Standards: ISO 3795, UNECE R119, DIN 75200, FMVSS 302 ...
- **Density**
  - Standards: ISO 1183-1, ISO 2781 ...
- **Coating gloss (20°, 60°, 85°)**
  - Standards: ISO 2813
- **Hardnes**
  - Standards: Sh A, Sh AM, IRHD-M
- **Wear resistance - abrasion**
  - Standards: ISO 15082, ISO 7784-2, ISO 105-12 ...



And many others....

[RETURN](#)



## Aging tests, climatic and temperature tests, corrosion resistance

The Institute offers a wide range of tests in climatic, temperature, pressure and salt chambers

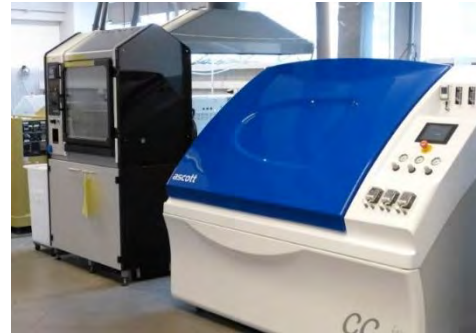

[RETURN](#)





# EXEMPLARY TESTING EQUIPMENT

Agilent 7890A gas chromatograph



Emission of hydrocarbons and freons



Chemical composition of materials



Tests of volatile compounds



Odour testing



Microstructure of metals and metal alloys



Liquid chromatography



Internal and external cleanliness of products



Product light and weather conditions resistance tests



Color spectrophotometric measurements



Aging tests, environmental tests, pressure cycles, resistance to low and high temperatures



Materials, coatings, components corrosion resistance tests



[RETURN](#)



## Chemical Laboratory:

- Identification
- Chemical composition
- Emissions
- Cleanliness



## Metallographic Laboratory:

- Mechanical properties
- Microscopic analyses
- Failure analyses



## Plastic, Rubber and Coatings Laboratory

- Environmental resistance (temperature, humidity, light ...)
- Corrosion resistance
- Mechanical properties
- Physico-chemical properties (flammability, abrasion, impact resistance ...)



[RETURN](#)





## Scope of Accreditation of the Testing Laboratory No. AB 128

Issued by: POLISH CENTRE FOR ACCREDITATION. Issue No. 22B, date of issue 6<sup>th</sup> June 2023

The scope of Accreditation covers methods from the following fields:

AB 128	BOSMAL AUTOMOTIVE RESEARCH AND DEVELOPMENT INSTITUTE LTD TESTING LABORATORY
Identification Code of domain/object (objects) of tests:	Field of testing and item
A/6; A/8; A/26	Acoustic and vibration tests of electrical products and equipment, construction products and equipment, vehicles
C/4; C/8; C/9 C/10, C/12; C/13; C/21; C/23; C/26; C/45; C/46	Chemical tests of chemical products, construction products and materials, air, fuels, glass and ceramics, construction products and materials, machinery and devices, plastic and rubber products, textiles and leather, vehicles, paints and varnishes, lubricating materials
E/6; E/26; E/34; E/35; E/54	Electric and electronic tests of electrical and electronic products and vehicles
F/6; F/54	Electromagnetic compatibility (EMC) tests of electrical, and electronic products and equipment
G/6; G/8; G/13; G/21; G/23; G/45; G/54	Tests concerning environmental engineering of electrical and electronic equipment, construction products and materials, machinery and devices, plastic and rubber products, textiles and leather, paints and varnishes
H/6; H/21; H/23	Fire tests of electrical products and equipment, plastic and rubber products, textiles and leather
J/6; J/8; J/21; J/23; J/26; J/45	Mechanical tests, metallographic tests of construction products and materials, plastic and rubber products, textiles and leather, paints and varnishes and vehicles
L/6; L/8; L/17; L/21	Non-destructive testing of metal products and materials, electrical products and equipment, construction products and materials, other products, plastic and rubber products
N/6; N/8; N/10; N/12; N/13; N/19; N/21; N/23; N/26; N/35; N/45; N/46; N/54	Tests of physical properties of electrical and electronic equipment, construction products and materials, glass and ceramics, plastic and rubber products, personal protection equipment, fuels, textiles and leather, paints and varnishes, lubricating materials and vehicles
Q/21; Q/23	Sensory tests of plastic and rubber products, textiles



Accreditation Certificate of Testing Laboratory No AB 128 confirms that BOSMAL meets requirements of the PN-EN ISO/IEC 17025:2018-02 standard



AB 128

Detailed scope of Accreditation of the Testing Laboratory No. AB 128 see: [www.bosmal.com.pl](http://www.bosmal.com.pl)



**RETURN**



### PCBC Certificate AQAP 2110:2016 NATO requirements for quality assurance in design, development and manufacture No. A-73/1/2021

System in the following scope of activities: **research, laboratory testing, development and implementation, engineering services, technical consulting, training, design, development, manufacture, distribution and service in the field of transport and their equipment** is in conformance with the standard **AQAP 2110:2016**

Certificate AQAP 2110:2016 PCBC Nr A-73/1/2021 is valid from 10.08.2021 do 09.08.2024. From September 10, 2021, a certification unit changed from CCJ to PCBC. Previous certificates: since 26.10.2015 - Certificate AQAP 2110:2009 CCJ WAT Nr 1124/A/2015, and since 10.08.2018 – Certificate AQAP 2110:2016 CCJ WAT Nr 1124/A/2018.



### PCA Accreditation Certificate of Testing Laboratory No. AB 128 BOSMAL laboratory meets requirements of the PN-EN ISO/IEC 17025:2018-02 standard. Accredited activities are defined in **the Scope of Accreditation No. AB 128**



AB 128



### TDT Certificate of Approval No. 4 022 2010 L

This is to confirm that Testing Laboratory fulfilling the criteria of the standard PN-EN ISO/IEC 17025:2018-02 granted approval on conducting tests a range listed enclosure for: certification body TDT-CERT



4 022 2010 L



[RETURN](#)





### PCBC Certificate No. JBS-199/4/2021

System in the following scope of activities:  
**design, testing and production of components for vehicles and their equipment, as well as test station and equipment for research and production** is in conformance with  
**PN-EN ISO 9001:2015-10, PN-ISO 45001:2018-06 and PN-EN ISO 14001:2015-09**



### IQNet Certificate of Integrated Management System No. PL-JBS – 199/4/2021

In the following scope of activities:  
**design, testing and production of components for vehicles and their equipment, as well as test station and equipment for research and production** system fulfills the requirements of the following standards:  
**PN-EN ISO 9001:2015-10, PN-ISO 45001:2018-06 and PN-EN ISO 14001:2015-09**



### TISAX label

Assessment of the BOSMAL for compliance with the **VDA-ISA** requirements, which includes the key security features of **ISO 27001** standard and additional criteria that relate to the automotive sector. The results of the assessment are available on the ENX platform:  
<https://portal.enx.com/en-US/TISAX/tisaxassessmentresults>



SCOPE-ID: ST38TZ  
<https://enx.com/tisax>





# CUSTOMERS' RECOMMENDATIONS AND ACCREDITATIONS

## Recommendation of Stellantis:



- for BOSMAL's tests in range of qualitative qualification of parts and assemblies to final assembly in Fiat manufacturing plants in Poland



**Acceptance of Volvo Car Corporation** for BOSMAL interior emission tests (formaldehyde acc. to VCS 1027,2739 and fogging acc. to VCS 1027,2719)



**Accreditation of Swiss Federal Office for the Environment (FOEN)** for BOSMAL as testing laboratory for tests according to the Swiss Federal Ordinance on Air Pollution Control (OAPC)



- for BOSMAL to carry out certain laboratory test work for Opel Plants



**BOSMAL LABORATORY APPROVAL FROM VOLKSWAGEN GROUP** - BOSMAL certified to perform material testing for Volkswagen Group suppliers with the negative Material Sampling Performance as per VW 52000 Standard. List of laboratories certified by the VW Group - on Volkswagen Group platform: [ONE.Konzern Business Plattform \(ONE.KBP\)](#)

**Acceptance of VOLKSWAGEN Group** for BOSMAL laboratory for emission tests required by VW 50180: standards PV3015 (fogging), PV3341 (VOC, headspace), PV3925 (formaldehyde, UV/VIS or HPLC), PV3900 (odour) and PV3942 (VOC, chamber emission tests).

**Acceptance of BMW** for BOSMAL laboratory for emission tests required by standards: VDA270 (odour), VDA278 (VOC and FOG, thermodesorption), GS97014-2 (CARB-Test, CARB-Screening), AA-0061 (formaldehyde and acetaldehyde, HPLC)

**Award for the best supplier of the year 2018 in the Engineering Services category of "FCA EMEA AWARD 2018"**



## Certificate of Business Credibility

BOSMAL - awarded for the highest evaluation of company stability in 2018 according to Bisnode Polska sp. z o.o.



## Membership



Polish Cluster of Composite Technologies



Polish Scientific Society of Combustion Engines



Klub Polskich Laboratoriów Badawczych POLLAB



**PKN**  
(Polish Committee for Standardization)

[RETURN](#)





- **SCOPE OF ACCREDITATION OF THE TESTING LABORATORY NO. AB 128**
- **CERTIFICATES, RECOMMENDATIONS, AWARDS AND DISTINCTIONS**
- **CONTACT – [kam@bosmal.com.pl](mailto:kam@bosmal.com.pl), +48 33 8130 544, +48 33 8130 462**



AB 128



SCOPE-ID: ST38TZ  
<https://enx.com/tisax>



4 022 2010 L

## We welcome your business

- Material identification
- Chemical composition
- Emissions from materials
- Internal and external cleanliness of products
- Metallographic analyses
- Scanning electron microscopy (SEM)
- Environmental resistance
- Corrosion testing
- Physico-chemical properties
- Component & assembly testing
- Exemplary research equipment
- Accreditation
- Certificates
- Customers' recommendations and accreditations



**RETURN**

50 years on the automotive market & 25 years as an Accredited Testing Laboratory AB 128

**FIND OUT MORE**

**WWW**

**THANK YOU FOR YOUR ATTENTION**





MATERIAL TESTING

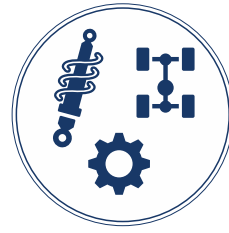

COMPONENT  
& ASSEMBLY TESTING



ROAD TESTING, EMISSION TESTING &  
ENGINE/POWERTRAIN TESTING

# BOSMAL component & assembly testing



PROTOTYPING, MANUFACTURING, ENGINEERING  
& PRODUCTION AUTOMATION



ENGINEERING  
SERVICES



HOMOLOGATION  
TYPE APPROVAL

[RETURN](#)

[SEE MORE](#)

[WWW](#)



# DURABILITY AND FATIGUE TESTS OF AUTOMOTIVE PARTS AND ASSEMBLIES

- Durability and fatigue tests of automotive parts and assemblies
- Heat exchangers testing
- Transmission testing
- Braking systems testing
- Vibration tests
- Vibration, vibroacoustic (NVH)
- High pressure tests
- Water & dust resistance
- Aging, climate, temperature, corrosion tests
- Photometric and photobiological measurements, thermovision
- Electric/ electronic automotive components testing
- Battery tests
- Electromobility
- Metrological measurements
- Accreditation
- Certificates
- Customers' recommendations and accreditations

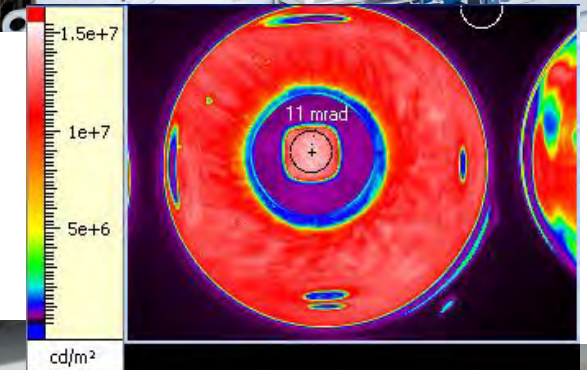
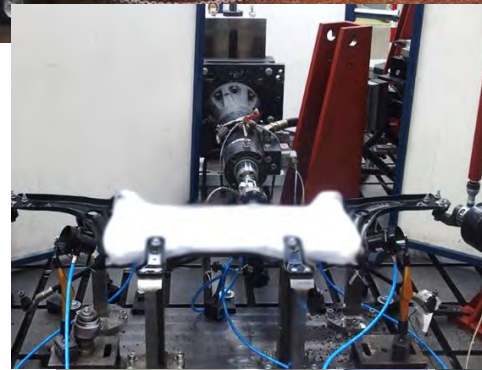
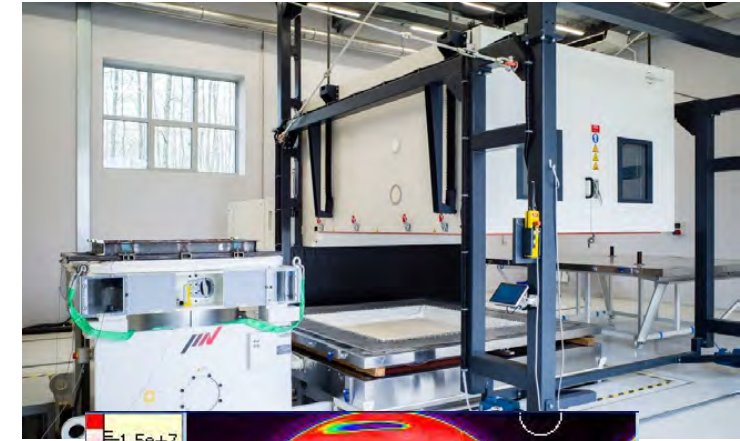

[RETURN](#)





## Durability and fatigue tests

- Durability tests of various parts and assemblies, e.g. two-dimensional loads - rotation and force control
- Fatigue tests of assemblies, e.g. radiators, cooling fans, fuel tanks
- Fatigue test of the shock absorbers
- Squeak and rattles tests
- Fatigue tests of components and systems loaded with Power Spectrum Density (PSD) signals
- Static and dynamic torsion tests of various parts

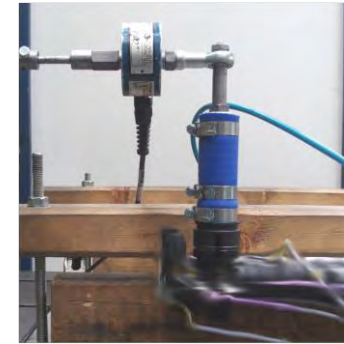
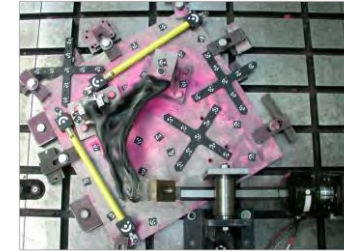

MTS and INOVA multiaxial test stands

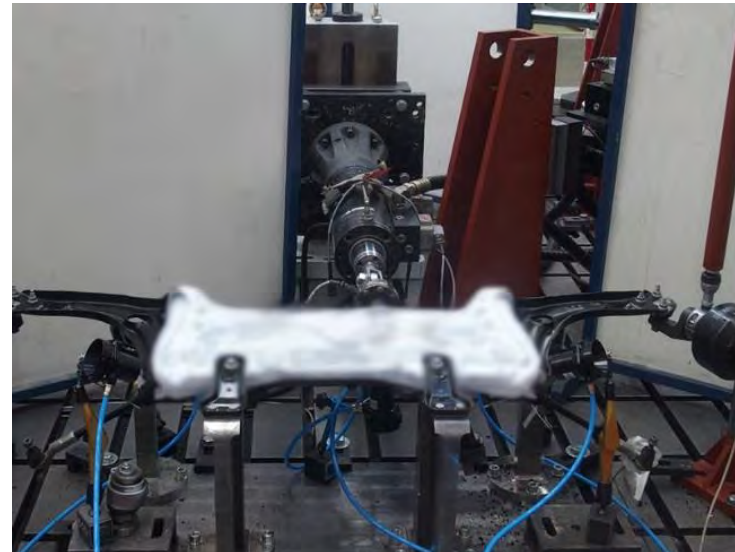
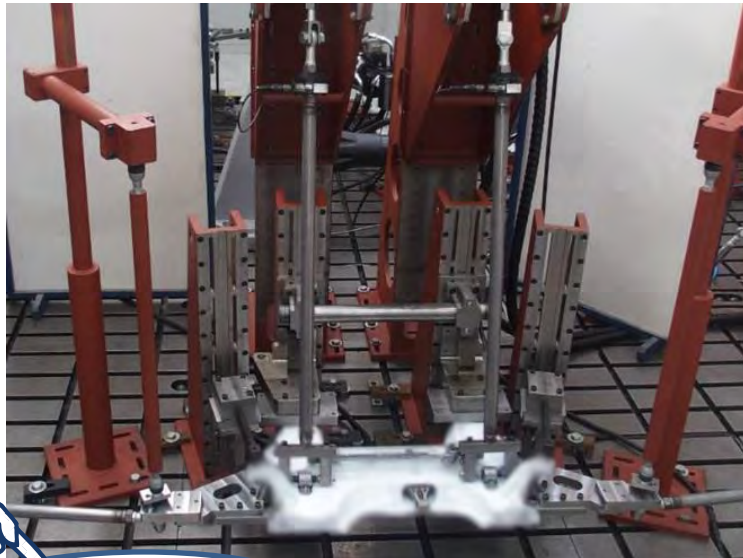

Durability test – multiaxial load



[RETURN](#)



## The scope of heat exchangers tests:

- pressure cycles
- thermal efficiency
- thermal shocks
- thermovision measurements
- ageing
- internal / external corrosion / erosion
- freon emission
- helium tightness – product tightness tests
- vacuum resistance - product tightness tests
- water resistance
- metallographic
- cleanness
- vibration
- durability tests of electric fans
- acoustic measurements in an anechoic chamber
- burst tests
- strain gauge measurements
- fatigue and durability

## Tests of:

- Coolers
- Heater cores
- Intercoolers
- Condensers
- Fans + shrouds

## Tests according to the standards of:

BMW, FIAT, Ford, GM, Jaguar, Mazda, Mercedes, Nissan, PSA, Renault, Volvo, VW, Toyota i innych.



Pressure cycles (ait)

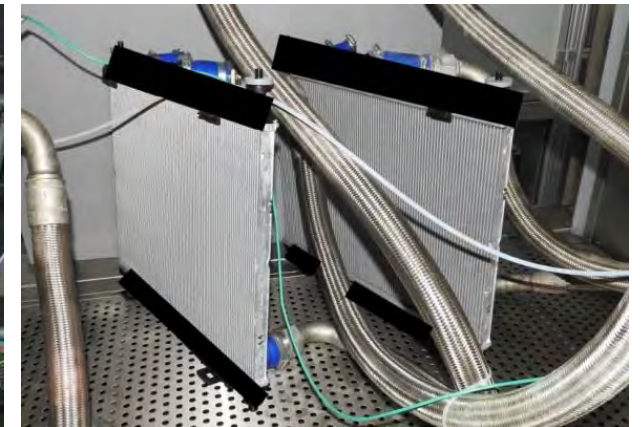

Internal erosion test

[RETURN](#)





## Dynamic transmission test bed for both manual, automatic transmissions and eDrive – drivetrain testing

- Suitable for both manual, automatic transmission and eDrive – drivetrain testing activity
- Durability and dynamic tests of transverse 4x2 drive systems
- Simulation of road load, vehicle, engine, driver, vehicle brake and starter
- Control of vehicle speed via accelerator pedal and vehicle brake (acceleration and deceleration)
- Simulation of various driving behavior (sporty, economic behavior, ...)
- Simulation of various driving situations (starting from rest, acceleration, deceleration, hill driving, coast down)
- Vibration spectrum analysis with **Reilhofer deltaAnalyser**



eDrive gearbox testing

## eDrive drivetrain testing with 250kW emulator

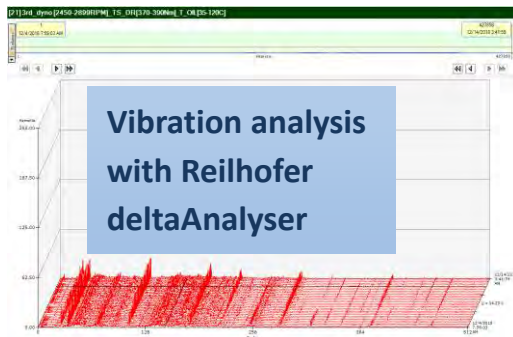

## Steady state transmission test bed for manual transmissions

- Suitable for manual transmissions testing
- Steady state durability tests of transverse 4x2 drive systems
- Vibration spectrum analysis with Reilhofer delta Analyser

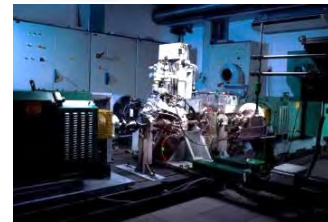

[RETURN](#)



## Capabilities:

- Performance testing
- Effectiveness / friction characteristics / friction coefficient testing
- Fade / mountain descend
- Friction material wear simulation
- Thermal fatigue / cracking tests
- High load / strength tests
- NVH – Noise & Vibration measurements (AK-Noise ABC Sections)
- DTV – Disc Thickness Variation measurements
- Static torque simulation
- Parking brake system
- Water spray system
- SAE, ISO, JASO, UNECE and OE, OES & OEM test specification

Functional and durability tests of disc and drum brakes on a real scale of :

- friction linings: brake pads and shoes
- brake drums
- full and ventilated brake discs of each type and made of each material

Technical specification	
DC Drive Motor	186 kW
Speed range	0 - 2800 rpm
Braking torque	0 - 8000 Nm
Inertia	5 - 250 kgm <sup>2</sup>
Pressure	0 - 205 bar
NVH	Class 1 - Noise & Vibration
DTV	4 capacitive sensors
Static torque	0 – 18 rpm / 5650 Nm
Parking brake system	3,3 kN / 2600N/s
Cooling air	-10°C - 40°C / up to 100kph



Dynamometer LINK Model M300

## Standards:

- UN ECE R90
- SAE-J2521 – „AK-Noise”
- SAE-J2522 – „AK-Master”
- ISO 26867
- SAE-J2784
- SAE-J2928
- JASO C406
- JASO C419
- JASO C427
- JASO C443
- ISO 11157
- ISO 15484
- and many more
- ECE R13
- ECE R13-H
- ECE-R78
- SAE-J2707

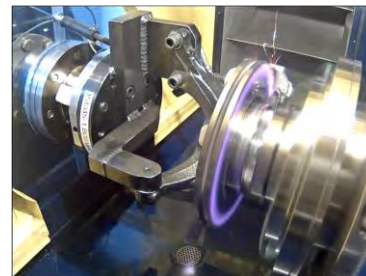

[RETURN](#)





## Vibration tests



### Parameters of Vibration System 36kN

- frequency range: 4...3000 Hz
- maximum displacement: 76 mm
- maximum acceleration: 100 g (sinus/random) 260 g (mechanical shocks)
- maximum load up to 600 kg
- head-expander dimension: 600 x 600 mm
- slip table dimension: 900 x 900 mm

### Parameters of Climats Climatic chamber

- internal dimension: 1500x1500x1500 mm
- temperature range: -70...180 st.C (10K/min)
- humidity: 10...98 % RH

**Basic tests** sinusoidal vibration tests, random vibration tests, vibration tests based on stored time signals (road tests), mechanical shock tests (pulses shape: half-sine, trapezoidal, sawtooth)

**Testing according to various standards** ECE R100, IEC 60068-2-6, IEC 60068-2-64, IEC 60068-2-27, VW80000, BMW GS97073-1, Renault 31-07-004, Toyota TSC3000 and other



### Parameters of Vibration System 80kN

- frequency range: 4...2000 Hz
- maximum displacement: 76 mm
- maximum acceleration: 100 g (sinus/random) 260 g (mechanical shocks)
- maximum load up to 1000 kg
- head-expander dimension: 800 x 800 mm (guided)
- slip table dimension: 1200 x 1200 mm

### Parameters of Climats Climatic chamber

- internal dimension: 1500x1500x1500 mm
- temperature range: -70...180 st.C (10K/min)
- humidity: 10...98 % RH



*new vibration system dedicated to EV large battery pack testing*

### Parameters of Vibration System 125kN

- frequency range: 4...2000 Hz
- maximum displacement: 100mm
- maximum acceleration: 100 g (sinus/random) 200 g (mechanical shocks)
- maximum load up to 2000 kg
- head-expander dimension: 1200 x 1200 mm (guided)
- slip table dimension: 1500 x 1500 mm

### Parameters of Climats Climatic chamber

- internal dimension: 2800x2500x1400 mm
- temperature range: -45...180 st.C (5K/min)
- humidity: 10...98 % RH

[RETURN](#)



## Mechanical tests

### Battery Pack Tests:

- vibration resistance (with parameters monitoring, coolant circulation charging)
- shocks (Reg. 100 Annex 8C)
- integrity (Reg. 100 Annex 8D)
- free fall
- dropping
- crush

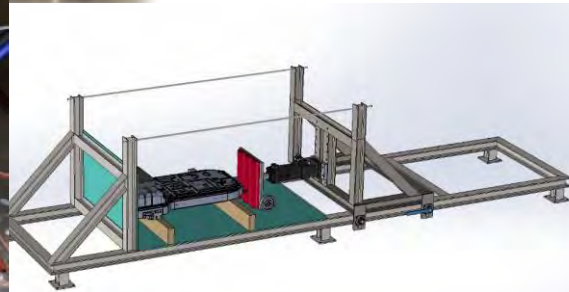

### Testing of electric vehicle components:

- battery management system - BMS (with loading)
- battery packs (charge/discharge)
- wires (high voltage wires, cables, bundles, connectors)
- components of the drive system
- communication/entertainment systems
- other electric car equipment (generators, actuators, valves, wipers, heat pumps, PTC heaters, heat exchangers, mirrors)
- LED/conventional lighting
- controllers / charging systems
- charging controllers / systems
- ADAS/LIDAR components
- vision systems



vibration stands with climatic chambers

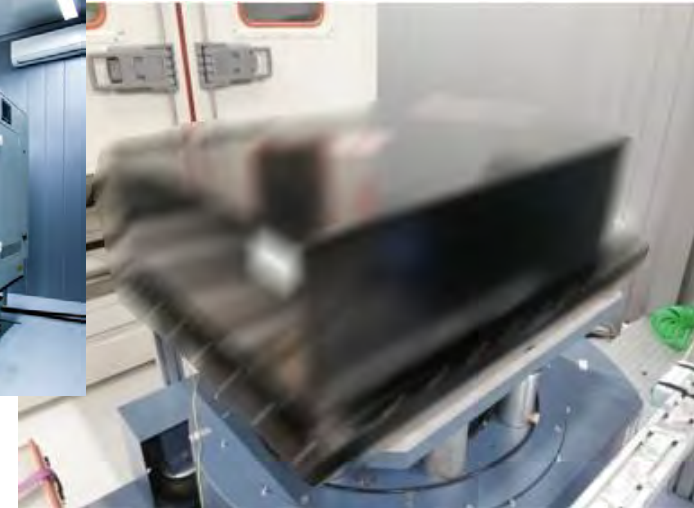

[RETURN](#)





## BOSMAL performs various types of battery tests:

- measurements of electrical parameters and characteristics,
- charge/discharge cycles.
- tests of resistance to environmental conditions,
- mechanical tests (pressure, burst)
- vibration tests
- fire resistance
- water resistance
- dust resistance
- corrosion resistance
- material tests



Large-dimension climatic chamber  
3x7x9 m

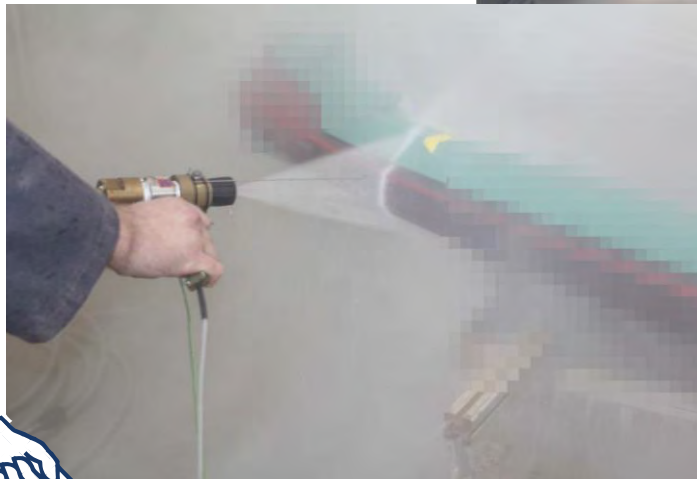

Climats climatic walk-in chamber  
2x2x2 m

[RETURN](#)



## Vibration, vibroacoustic (NVH) and strain gauge tests

Analyses and solve vibration and acoustic problems in vehicles and vehicle systems, in test bench setups and in other systems

Tests of resistance to sinusoidal vibrations, random vibrations and shocks for forcing in 3 axes sequentially under various climatic conditions.

### Examples of NVH tests:

- Vibroacoustic (NVH) testing of braking systems
- Noise and vibration (during road testing)
- Vibroacoustic analysis for transmission tests
- Testing resistance to acoustic vibrations
- Vibroacoustic analysis of engines
- Vibroacoustic device measurements
- Acoustic measurements in an anechoic chamber
- Vibration tests
- Strain gauge measurements
- Testing the acoustic properties of materials
- Modal analysis



A vehicle's lamp on a vibrating stand



Vibration measurement of engine accessories



Stand for testing the acoustic properties of materials

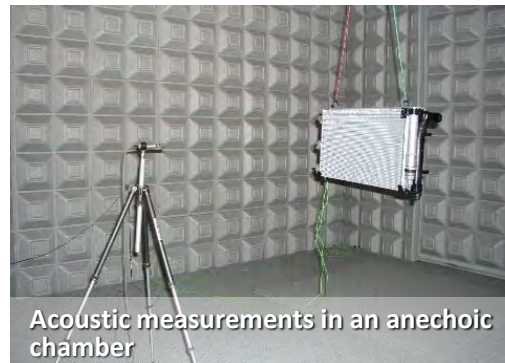

Acoustic measurements in an anechoic chamber

### Strain gauge measurements (tensometric testing):

- direct measurements of strains using strain gauges at temperatures up to 200 ° C
- static, quasi-static and dynamic measurements
- main aim of strain research:
  - Comparison of real values with calculations
  - Assurance of fatigue tests repeatability on various test stands and in different laboratories
  - Determining the root cause of too early cracks
  - Indirect measurements of forces in mechanical system

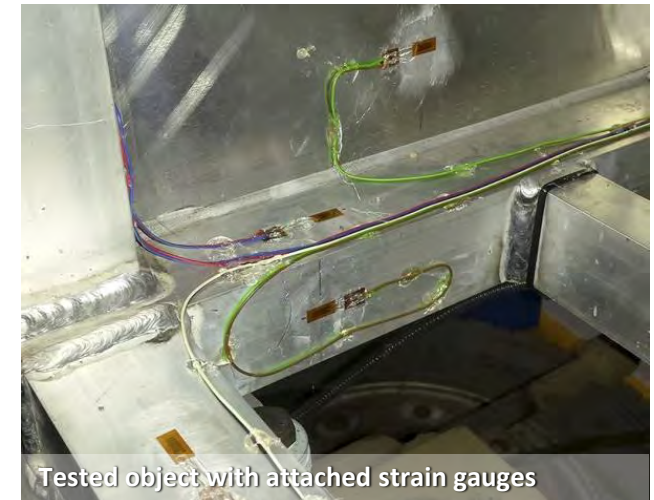

Tested object with attached strain gauges

[RETURN](#)





## High pressure pulsations/ pressure change resistance tests

High pressure pulsations or pressure change resistance tests are usually performed in the pressure range from 0 to 200 bar; to meet special requirements it is also possible to carry out such tests at higher pressures. Testing can be performed using different types of media at a variety of variable temperatures. Often we carry out tests according to DIN SPEC 74104.

### Pressure range

- 0 - 200 bar
- > 200 bar - to be agreed upon

### Medium

- hydraulic oil
- water
- glycol
- brake fluid
- other media on request

### Temperature range

- From -40°C to +180°C
- From ambient to +300°C

### Pulse shape

- practically any – to be agreed with Client
- high accuracy of tracking the required pulse shape

### Data acquisition

- Pressure and temperature data acquisition throughout the entire test
- Testing several objects simultaneously (up to 5 items)



Charts: Examples of pressure change tests

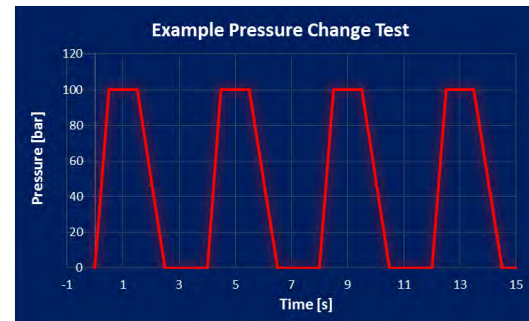
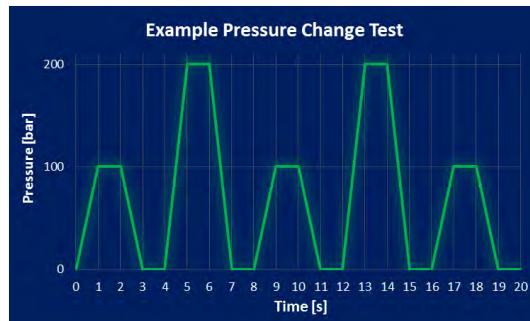

## Bursting pressure resistance tests (burst tests)

Burst tests, commonly called burst pressure resistance tests, are typically carried out at pressures up to 1000 bar with different media at varying ambient temperatures.

### Tests may apply to:

- Heat exchangers
- Brake Master Cylinders
- Brake Calipers
- Whell Brake Cylinder
- Brake lines
- Brake hoses
- and other

[RETURN](#)



## Resistance to water:

- resistance to dripping water (IPX1, IPX2)
- resistance to rain (IPX3, IPX4) using a tube with oscillating movement,
- resistance to spurts of water (IPX5, IPX6, IPX6K),
- immersion (IPX7, IPX8),
- **resistance to high-pressure washing (IPX9, IPX9K).**



## Resistance to dust (IP5X/IP6X) according to PN-EN 60529 and ISO 20653

### Objects tested

- elements of electrical and electronic equipment,
- assemblies for machines and devices.



## Thermal shocks with cold water (Splash Test)



[RETURN](#)





## Photometric measurements:

- luminance using matrix luminance meter or a single spot photometer
- luminous intensity distributions effective intensity of flashing lights
- effective luminous intensity of flashing lights, time parameters
- colour of light, correlated colour temperature, colour rendering index
- CIL reflection coefficient, surface density of reflection coefficient
- spectroradiometric measurements: UV (200-400 nm),
- VIS (380-780 nm), NIR (780-1100 nm)
- blue light hazard measurements
- reflectance, transmittance and haze

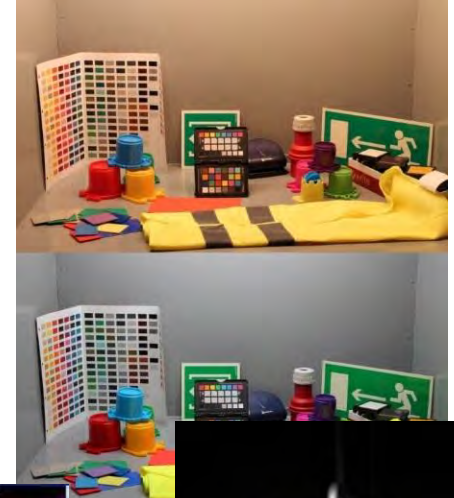
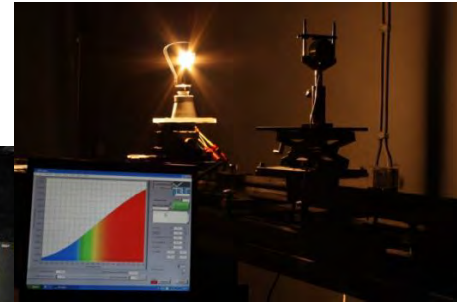
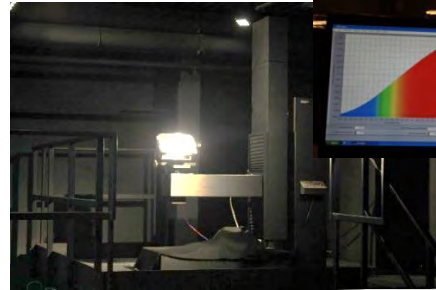

## Photobiological risk assessment

Blue light hazard of lighting devices acc. PN-EN 62471:2010, IEC TR 62778

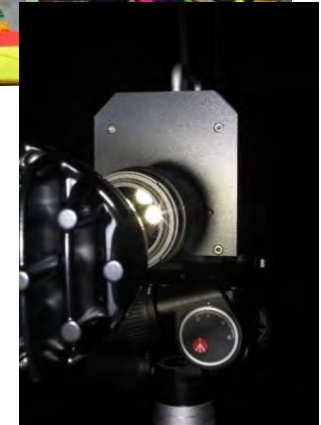
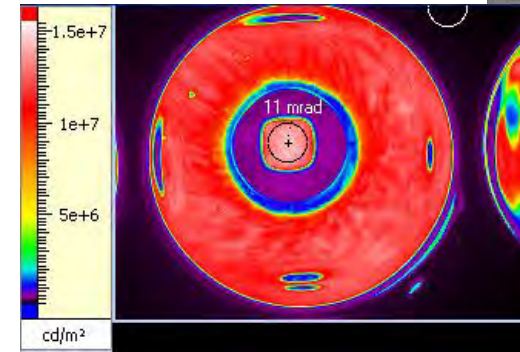
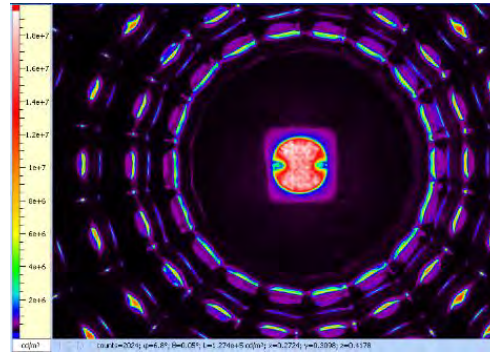

## Thermovision FLIRT1030sc

non-contact detection of electromagnetic radiation in the mid-infrared band (wavelength from approximately 0.9 μm to 14 μm).

Temperature range of the tested object - from about -40 °C to about + 2000 °C.

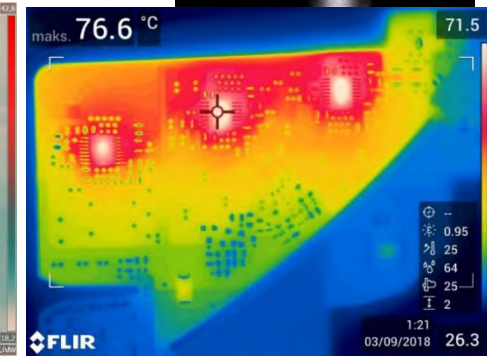
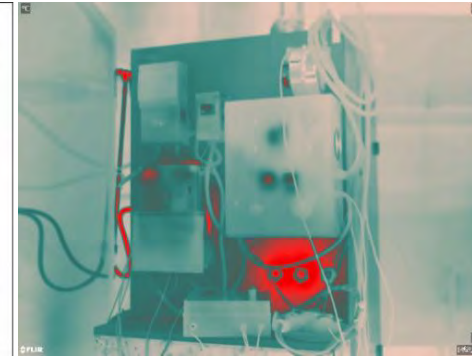
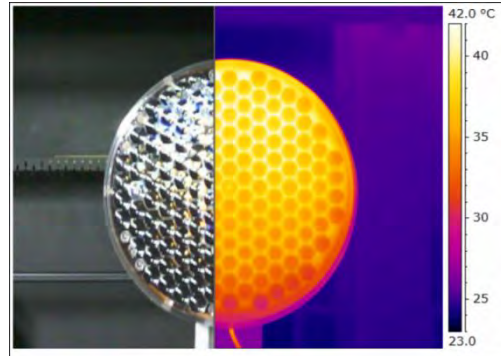

[RETURN](#)



## Electric/ Electronic Automotive Components Testing

Testing electrical and electronic vehicle systems (battery, electric fan, alternator, sensors and transducers, lighting systems, wiring harnesses, connectors, push connections, windscreen wiper system, window)

Measurements of electrical and functional characteristics, EMC/ESD tests and durability tests of elements and assemblies of electrical and electronic equipment.

Properties of insulating materials - electrical characteristics (electrical resistance, antistatic properties, high voltage tests) of plastic products, rubber, fabrics and textiles and other items used in components for vehicles and other equipment.

### EMC (Electromagnetic compatibility) and ESD (Electrostatic discharge) testing

- tests of resistance of electric and electronic devices to interferences, transients conducted by the power line (EMD).
- tests of resistance of electric and electronic devices to electrostatic discharge (ESD).

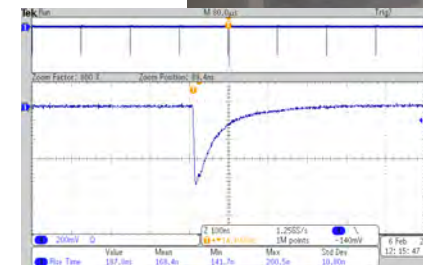
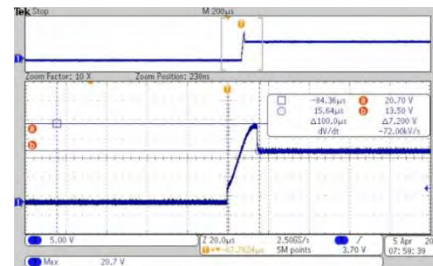
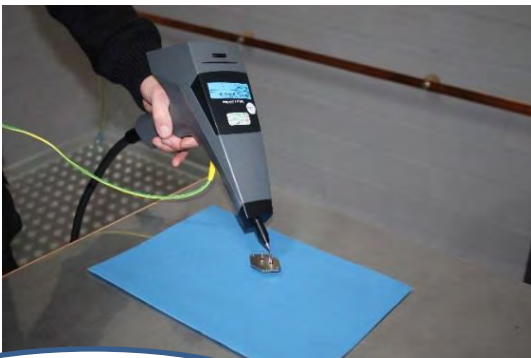
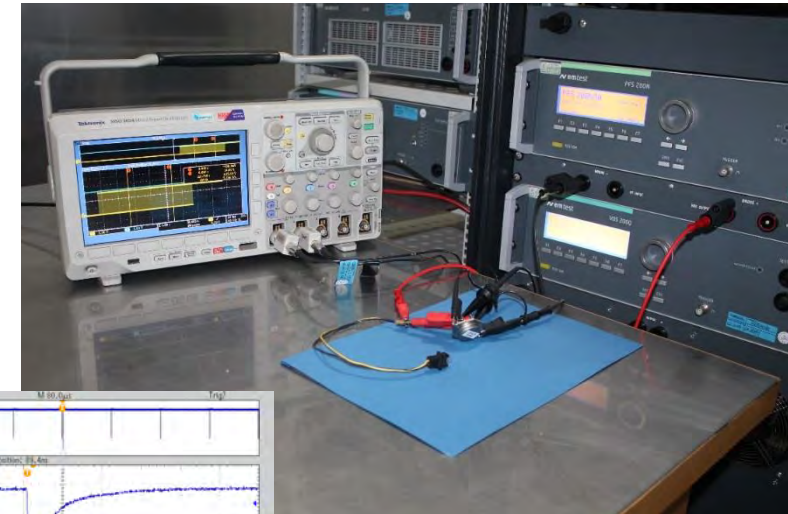

[RETURN](#)





## Aging tests, climatic and temperature tests, corrosion resistance

The Institute offers a wide range of tests in climatic, temperature, pressure and salt chambers



[RETURN](#)





## BOSMAL's research capabilities in the field of electric vehicles

Electric Vehicles Research, performed according to R101 requirements under standard and non-standard ambient conditions:

- range determination, measurement of wheel power and energy consumption

## BOSMAL's other services/ research on electric vehicles

- road tests of functionality and durability under various traffic and climate conditions,
- measurements of geometric dimensions
- evaluations of vehicles and their electric components in terms of security
- evaluation of traction performance (maximum speed, acceleration capacity from a standstill or from a specific starting speed)
- evaluation of operating properties (vehicle real range on different routes, with various driving styles, at sub-zero temperatures)
- tests of the influence of ambient temperature (low, ambient, high) on the efficiency of the electrical energy storage system, its processing system, the mechanical efficiency of the transmission, and the range and performance of the entire drivetrain
- evaluation of steerability and stability of the vehicle on the road
- brake assist and steering system assessment
- assessment of ventilation and heating systems' efficiency
- tests of battery charging parameters (charging time, charging current, temperature of battery cells, others)
- measurements of temperatures of motor and battery parts during operation



Examples of vehicle conversion

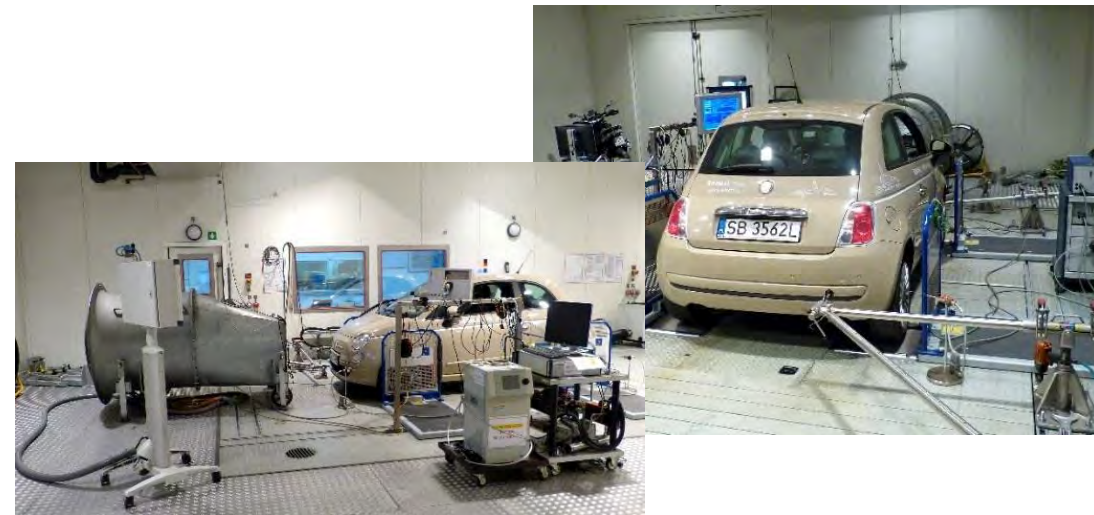

[RETURN](#)





The range of measurement services includes::

- Contact measurements of length and angle, deviations of shape and position
- Non-contact measurements of length and angle, deviations of shape and position
- Measurements of surface roughness
- Comprehensive measurements of complicated shapes and technological devices
- Measurements of series of products using measuring programs
- Dimensional control and deviations of position and shape of the product at the prototyping stage, as well as during series production
- Preparation of professional measurement reports, taking into account customer requirements.



**OPTIV CLASSIC 321GLTP**



Measuring machines:

- DEA GLOBAL PERFORMANCE (12.30.10) with measurement and inspection software PC-DMIS™ CAD++ On-line with DCT CATIA V5 and DCT UNIGRAPHICS
- DEA GLOBAL STATUS (09.15.08)
- HexMet-OPTIV CLASSIC 321GL tp
- Hexagon (ROMER) Absolute Arm 87 serie – mobile measuring arm - contact measurements and scanning



**DEA GLOBAL STATUS**



**Hexagon (ROMER)  
Absolute Arm 87 serie**



**DEA GLOBAL PERFORMANCE  
1200 X 3000 X 1000 mm**

[RETURN](#)



## Scope of Accreditation of the Testing Laboratory No. AB 128

Issued by: POLISH CENTRE FOR ACCREDITATION. Issue No. 22B, date of issue 6<sup>th</sup> June 2023

The scope of Accreditation covers methods from the following fields:

AB 128	BOSMAL AUTOMOTIVE RESEARCH AND DEVELOPMENT INSTITUTE LTD TESTING LABORATORY
Identification Code of domain/object (objects) of tests:	Field of testing and item
A/6; A/8; A/26	Acoustic and vibration tests of electrical products and equipment, construction products and equipment, vehicles
C/4; C/8; C/9 C/10, C/12; C/13; C/21; C/23; C/26; C/45; C/46	Chemical tests of chemical products, construction products and materials, air, fuels, glass and ceramics, construction products and materials, machinery and devices, plastic and rubber products, textiles and leather, vehicles, paints and varnishes, lubricating materials
E/6; E/26; E/34; E/35; E/54	Electric and electronic tests of electrical and electronic products and vehicles
F/6; F/54	Electromagnetic compatibility (EMC) tests of electrical, and electronic products and equipment
G/6; G/8; G/13; G/21; G/23; G/45; G/54	Tests concerning environmental engineering of electrical and electronic equipment, construction products and materials, machinery and devices, plastic and rubber products, textiles and leather, paints and varnishes
H/6; H/21; H/23	Fire tests of electrical products and equipment, plastic and rubber products, textiles and leather
J/6; J/8; J/21; J/23; J/26; J/45	Mechanical tests, metallographic tests of construction products and materials, plastic and rubber products, textiles and leather, paints and varnishes and vehicles
L/6; L/8; L/17; L/21	Non-destructive testing of metal products and materials, electrical products and equipment, construction products and materials, other products, plastic and rubber products
N/6; N/8; N/10; N/12; N/13; N/19; N/21; N/23; N/26; N/35; N/45; N/46; N/54	Tests of physical properties of electrical and electronic equipment, construction products and materials, glass and ceramics, plastic and rubber products, personal protection equipment, fuels, textiles and leather, paints and varnishes, lubricating materials and vehicles
Q/21; Q/23	Sensory tests of plastic and rubber products, textiles



Accreditation Certificate of Testing Laboratory No AB 128 confirms that BOSMAL meets requirements of the PN-EN ISO/IEC 17025:2018-02 standard



AB 128

Detailed scope of Accreditation of the Testing Laboratory No. AB 128 see: [www.bosmal.com.pl](http://www.bosmal.com.pl)



**RETURN**





### PCBC Certificate AQAP 2110:2016 NATO requirements for quality assurance in design, development and manufacture No. A-73/1/2021

System in the following scope of activities: **research, laboratory testing, development and implementation, engineering services, technical consulting, training, design, development, manufacture, distribution and service in the field of transport and their equipment** is in conformance with the standard **AQAP 2110:2016**

Certificate AQAP 2110:2016 PCBC Nr A-73/1/2021 is valid from 10.08.2021 do 09.08.2024. From September 10, 2021, a certification unit changed from CCJ to PCBC. Previous certificates: since 26.10.2015 - Certificate AQAP 2110:2009 CCJ WAT Nr 1124/A/2015, and since 10.08.2018 – Certificate AQAP 2110:2016 CCJ WAT Nr 1124/A/2018.



### PCA Accreditation Certificate of Testing Laboratory No. AB 128 BOSMAL laboratory meets requirements of the PN-EN ISO/IEC 17025:2018-02 standard. Accredited activities are defined in **the Scope of Accreditation No. AB 128**



AB 128



### TDT Certificate of Approval No. 4 022 2010 L

This is to confirm that Testing Laboratory fulfilling the criteria of the standard PN-EN ISO/IEC 17025:2018-02 granted approval on conducting tests a range listed enclosure for: certification body TDT-CERT



4 022 2010 L



[RETURN](#)



### PCBC Certificate No. JBS-199/4/2021

System in the following scope of activities:  
**design, testing and production of components for vehicles and their equipment, as well as test station and equipment for research and production** is in conformance with  
**PN-EN ISO 9001:2015-10, PN-ISO 45001:2018-06 and PN-EN ISO 14001:2015-09**



### IQNet Certificate of Integrated Management System No. PL-JBS – 199/4/2021

In the following scope of activities:  
**design, testing and production of components for vehicles and their equipment, as well as test station and equipment for research and production** system fulfills the requirements of the following standards:  
**PN-EN ISO 9001:2015-10, PN-ISO 45001:2018-06 and PN-EN ISO 14001:2015-09**



### TISAX label

Assessment of the BOSMAL for compliance with the **VDA-ISA** requirements, which includes the key security features of **ISO 27001** standard and additional criteria that relate to the automotive sector. The results of the assessment are available on the ENX platform:  
<https://portal.enx.com/en-US/TISAX/tisaxassessmentresults>



SCOPE-ID: ST38TZ  
<https://enx.com/tisax>







# CUSTOMERS' RECOMMENDATIONS AND ACCREDITATIONS

## Recommendation of Stellantis:



- for BOSMAL's tests in range of qualitative qualification of parts and assemblies to final assembly in Fiat manufacturing plants in Poland



**Acceptance of Volvo Car Corporation** for BOSMAL interior emission tests (formaldehyde acc. to VCS 1027,2739 and fogging acc. to VCS 1027,2719)



**Accreditation of Swiss Federal Office for the Environment (FOEN)** for BOSMAL as testing laboratory for tests according to the Swiss Federal Ordinance on Air Pollution Control (OAPC)



- for BOSMAL to carry out certain laboratory test work for Opel Plants



**BOSMAL LABORATORY APPROVAL FROM VOLKSWAGEN GROUP** - BOSMAL certified to perform material testing for Volkswagen Group suppliers with the negative Material Sampling Performance as per VW 52000 Standard. List of laboratories certified by the VW Group - on Volkswagen Group platform: [ONE.Konzern Business Plattform \(ONE.KBP\)](#)

**Acceptance of VOLKSWAGEN Group** for BOSMAL laboratory for emission tests required by VW 50180: standards PV3015 (fogging), PV3341 (VOC, headspace), PV3925 (formaldehyde, UV/VIS or HPLC), PV3900 (odour) and PV3942 (VOC, chamber emission tests).

**Acceptance of BMW** for BOSMAL laboratory for emission tests required by standards: VDA270 (odour), VDA278 (VOC and FOG, thermodesorption), GS97014-2 (CARB-Test, CARB-Screening), AA-0061 (formaldehyde and acetaldehyde, HPLC)

**Award for the best supplier of the year 2018 in the Engineering Services category of "FCA EMEA AWARD 2018"**



## Certificate of Business Credibility

BOSMAL - awarded for the highest evaluation of company stability in 2018 according to Bisnode Polska sp. z o.o.



## Membership



Polish Cluster of Composite Technologies



Polish Scientific Society of Combustion Engines



Klub Polskich Laboratoriów Badawczych POLLAB



**PKN**  
(Polish Committee for Standardization)

[RETURN](#)



- **SCOPE OF ACCREDITATION OF THE TESTING LABORATORY NO. AB 128**
- **CERTIFICATES, RECOMMENDATIONS, AWARDS AND DISTINCTIONS**
- **CONTACT – [kam@bosmal.com.pl](mailto:kam@bosmal.com.pl), +48 33 8130 544, +48 33 8130 462**

## We welcome your business

- Durability and fatigue tests of automotive parts and assemblies
- Heat exchangers testing
- Transmission testing
- Braking systems testing
- Vibration tests
- Vibration, vibroacoustic (NVH)
- High pressure tests
- Water & dust resistance
- Aging, climate, temperature, corrosion tests
- Photometric and photobiological measurements, thermovision
- Electric/ electronic automotive components testing
- Battery tests
- Electromobility
- Metrological measurements
- Accreditation
- Certificates
- Customers' recommendations and accreditations



SCOPE-ID: ST38TZ  
<https://enx.com/tisax>



**RETURN**

50 years on the automotive market & 25 years as an Accredited Testing Laboratory AB 128



**SEE MORE**  
**WWW**



**THANK YOU FOR YOUR ATTENTION**



MATERIAL TESTING

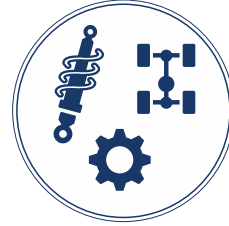

COMPONENT  
& ASSEMBLY TESTING



ROAD TESTING, EMISSION TESTING &  
ENGINE/POWERTRAIN TESTING

**BOSMAL**

# Road testing, emission testing & engine/powertrain testing



PROTOTYPING, MANUFACTURING, ENGINEERING  
& PRODUCTION AUTOMATION



ENGINEERING  
SERVICES



HOMOLOGATION  
TYPE APPROVAL

[RETURN](#)

[SEE MORE](#)

[www](http://www.bosmal.co.uk)





- **Vehicle testing**
- **SORT testing**
- **RDE testing**
- **Exhaust emission and fuel consumption test**
- **Conformity of production (COP)**
- **Engine testing**
- **Hybrid vehicle/powertrain testing**
- **Electromobility**
- **Accreditation**
- **Certificates**
- **Customers' recommendations and accreditations**

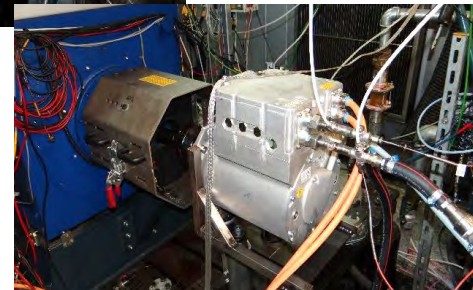
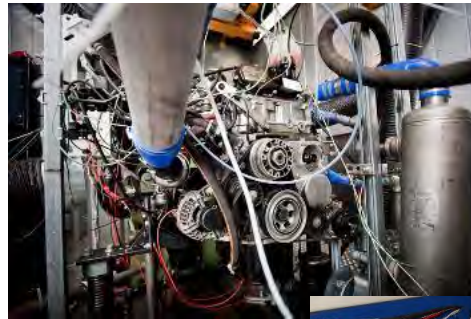

[RETURN](#)





## Durability-fatigue, functional and mileage tests of vehicles with ICE/ hybrid and electric powertrains:

- Road Measurement Tests
- Reliability growth tests
- Fleet – EOBD, ATS, WU, B-Cycle tests
- Tests of traction systems, e.g. ABS, ASR
- Validation calibrations in road test
- Modification of calibrations for improvement of drivability and real world fuel economy
- Road testing: validations (functionality and efficiency, reliability, durability)
- Temperature Chamber Test

## Various climatic conditions:

Hot/special climate:

- Torino (Santena) - Italy
- Modena (San Giovanni) - Italy
- Livigno - Italy
- Granada - Spain

Temperate climate:

- Bielsko-Biała - Poland
- Slovakia
- Serbia

Cold climate:

- Sweden

## Various testing tracks/roads:

- Urban
- Heavy urban
- Mountain
- High way
- High speed
- Extra urban
- Mixed
- Off-road
- Door-to-Door



ABS and ASR testing Tech. inspection, type approval



SORT



Workshop



Road test



PEMS testing (incl. RDE)



Road tests on advanced testing race tracks (Italy, Czech Republic, Germany, Sweden)

[RETURN](#)





## Exhaust gas emissions tests on vehicles in the real driving conditions (RDE) using Portable Emissions Measurement Systems (PEMS)

### Dynamic vehicle tests on 2WD and 4WD chassis dynos

- measurements of powertrain power and torque
- road inclination simulation
- engine operation control optimisation
- measurements of vehicle dynamics at temperatures from -35°C to 60°C (Chassis dyno – AVL Zoellner 48" 4WD, Climatic chamber – WEISS WK 643)

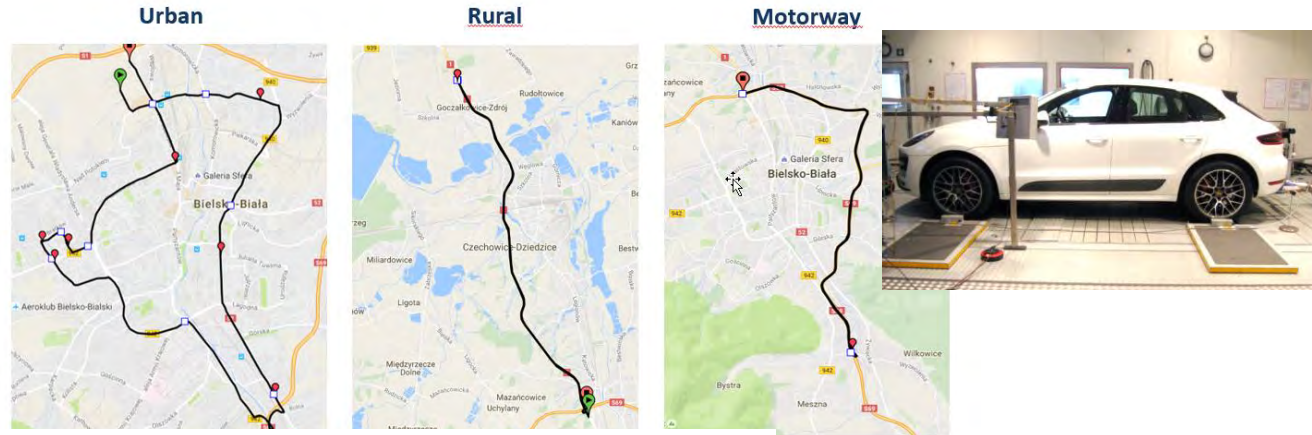

## Testing vehicles, machinery and devices in large-dimension chambers at high and low temperature (from -45°C to 75°C)

- Tests of air conditioning and internal heating systems
- Tests of batteries and heating and air conditioning systems installed in electric vehicle
- Start-up tests of combustion engines
- Windshield defrosting and demisting tests
- Durability and functional tests of vehicles, devices, machines and parts
- Start-up and pull-away tests of vehicles

Dimensions (length x width x height): 11500 x 4700 x 4200 mm



## Tests of electric and hybrid vehicles

### Standardised On-Road Tests (SORT) on electric buses

### Type approval tests (homologation)



Próby przebiegowe



Rain chamber

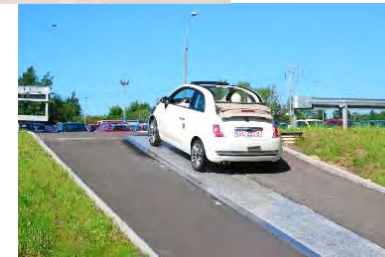

ABS i ASR testing



SORT

[RETURN](#)





## Fuel consumption of buses according to UITP Project SORT (Standardised On-Road Tests Cycles), New Edition UITP 2014; D/2014/0105/1

- for all types of city buses from small (9 m) up to large (18 m)
- for all types of engines from light-duty up to heavy duty engines



## Standardised On-Road Tests (SORT) on electric buses

- Vehicle Energy Consumption in steady and transient states
- Vehicle Energy Consumption in Standardized On-Road Tests (SORT)
- Battery Charger Efficiency
- Usable Energy in Battery Package (for E-Bus SORT methodology)
- Maximal Range in Standardized On-Road Tests (SORT)



[RETURN](#)





## RDE testing

- Exhaust gas emissions tests on vehicles in the real traffic conditions ('RDE') using Portable Emissions Measurement Systems (PEMS)
- Ranging from large heavy-duty engines to the smallest light-duty vehicles and, recently, to non-road mobile machinery
- The currently available PEMS analyzers measure gaseous exhaust components (CO<sub>2</sub>, CO, HC, NO<sub>x</sub>), particle number (PN)
- ECU datalogging, monitoring of electrical current and battery SOC, etc.
- Evaluation in accordance with the 4th RDE package (Regulation 2018/1832)



## Chassis dyno facilities: an essential tool in the RDE calibration process

- Calibration on vehicle on the chassis dyno
- Simulation of RDE on the chassis dyno
- Cold ambient calibration on the chassis dyno
- Cold/ hot temperature calibration/ testing on the chassis dyno with altitude simulation (planned to be implemented)
- ATS development on chassis dyno
- RDE (PEMS) validation on the road

All types of driving cycle and RDE simulation performed under the entire range of RDE boundary conditions and at -7°C

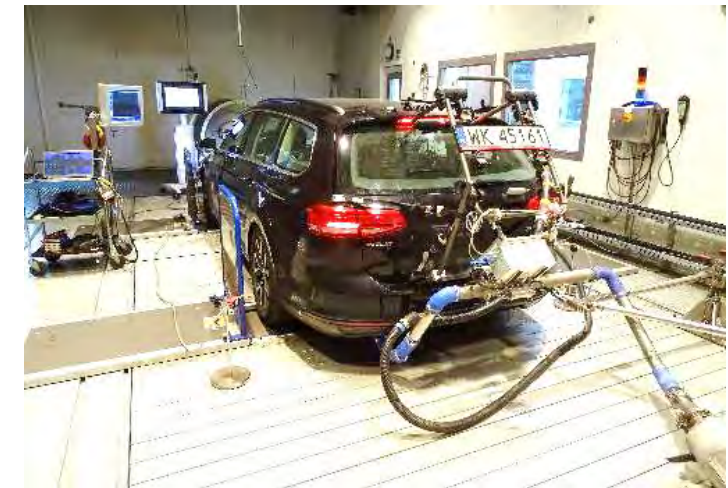

Chassis dyno verification of PEMS installation



[RETURN](#)





## E-motor and hybrid powertrains power measurements

YOKOGAWA High-Performance Power Analyzer

Measures accurately at a wide range of voltage, current and frequency conditions.

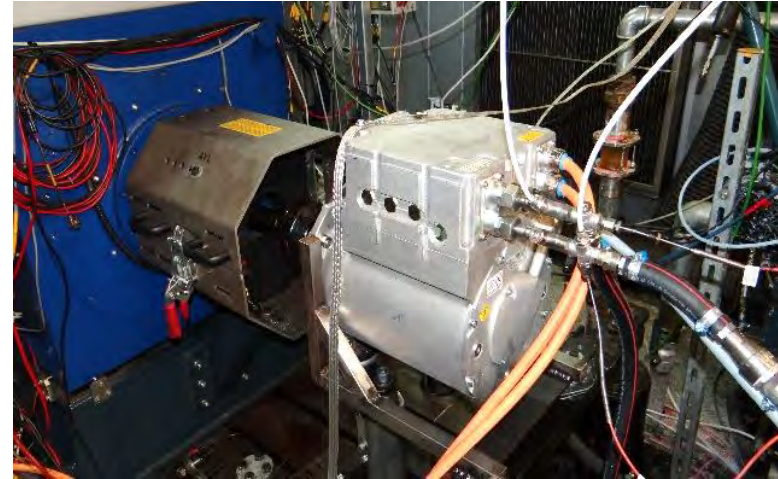

## Testing hybrid and electric vehicles

- Electric vehicle range determination
- Measurement of electric vehicles' electricity consumption
- Exhaust emission and fuel consumption tests of hybrid vehicles (including charge balance)
- Tests of batteries and heating and air conditioning systems installed in electric vehicles at temperatures from  $-45^{\circ}\text{C}$  to  $75^{\circ}\text{C}$
- $\text{CO}_2$  emission and fuel consumption testing (including consideration of the power balance)



Large dimension climatic chamber  
Temp.:  $-45^{\circ}\text{C}$  -  $+75^{\circ}\text{C}$

## Electric Vehicle Research, performed according to EU requirements (WLTP) under standard and non-standard ambient conditions:

- range determination, measurement of wheel power and energy consumption

## Type approval and COP testing of vehicles with pure electric powertrains

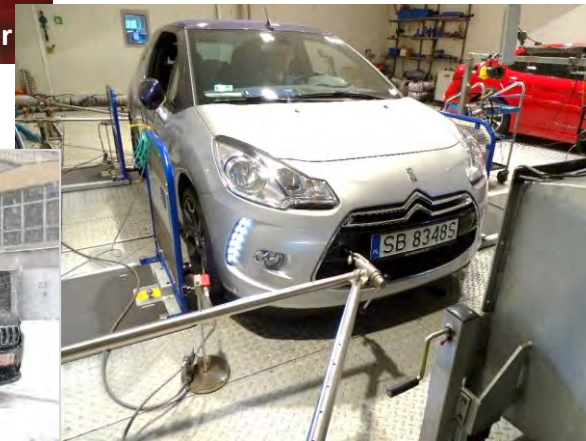
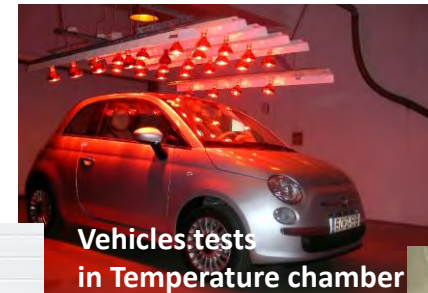

[RETURN](#)





## Activities carried out on hybrid vehicles/ powertrains

Chassis dyno: Start-Stop system validation, full hybrid vehicle emissions testing at multiple ambient temperatures and SOC (Status Of Charging) values; PER (Pure Electric Range) determination, etc.

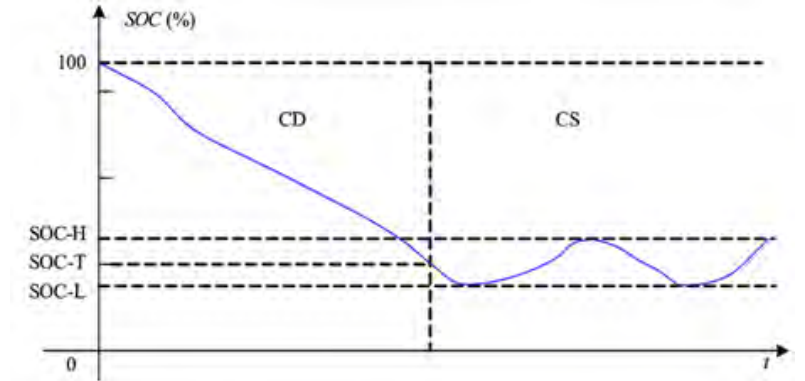

Engine dyno: durability testing of mild hybrid/ BSG (Belt Starter Generator ) systems with a low voltage battery emulator, Start-Stop system validation

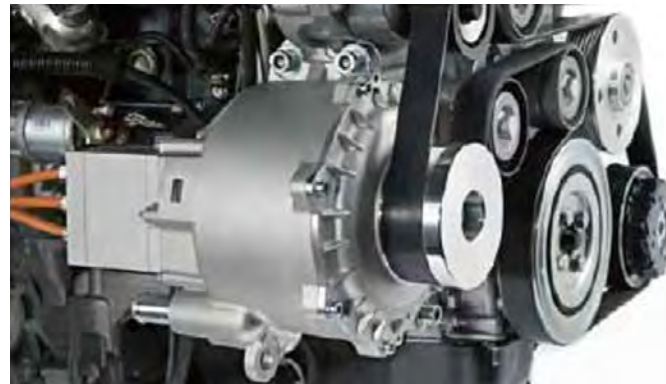

[RETURN](#)



## BOSMAL's research capabilities in the field of electric vehicles

**Electric Vehicle Research, performed according to EU requirements (WLTP) under standard and non-standard ambient conditions:**

- range determination, measurement of wheel power and energy consumption

### Testing hybrid and electric vehicles

- Electric vehicle range determination
- Measurement of electric vehicles' electricity consumption
- Exhaust emission and fuel consumption tests of hybrid vehicles (including charge balance)
- Tests of batteries and heating and air conditioning systems installed in electric vehicles at temperatures from -45°C to 75°C
- CO<sub>2</sub> emission and fuel consumption testing (including consideration of the power balance)

### Integration of components in electric vehicles:

- development of a project to convert combustion vehicles into electric ones
- conversion of combustion vehicles into electric ones for small series production,
- selection of drive components and supplementary units for electric vehicles (motor with a frequency inverter, battery, charging system, voltage inverters, components of electric supplementary units- heating elements, air conditioning compressor),
- preparation of algorithms of vehicle components control system with the electric drive and steering system integration with participation of the suppliers of main components, such as the motor and battery unit,
- harness design and modifications to the harness of the base vehicle (in the case of conversion),
- arrangement and mounting of powertrain components and supplementary units in the electric vehicle,
- complex tests for the purposes of EC type-approval (small series production).



[RETURN](#)





# EXHAUST EMISSION AND FUEL CONSUMPTION TESTING

## Exhaust emission and fuel consumption tests:

- Exhaust emission measurements via the CVS method with sample bags
- CO<sub>2</sub> emission and fuel consumption testing (including consideration of the power balance)
- continuous analysis of diluted and undiluted exhaust
- Catalytic gaseous (TWC, DOC, NSC, SCR) and particulate filter (DPF, GPF) aftertreatment efficiency tests
- Vehicle exhaust emission tests at temperatures from -35°C to 60°C
- PEMS – exhaust emissions testing under real driving conditions for light duty and heavy duty vehicles
- Continuous measurements of NH<sub>3</sub> concentrations and additionally N<sub>2</sub>O, NO and NO<sub>2</sub>
- Solid particle number (PN) measurement
- Continuous measurements of solid particle distribution (quantity and size)
- Continuous measurements of soot concentration
- Exhaust gas opacity measurements
- Exhaust emission and fuel consumption tests of hybrid vehicles (including charge balance)
- Testing for type approval

Exhaust emissions tests according to EU requirements (e.g. Euro 6d), EPA/CARB US norms (e.g. SULEV) and Japanese norms.

Emissions measurements of various types, carried out over a range of driving cycles, such as: WLTC, NEDC, FTP-75, HFET, JC08, WMTC, according to the requirements of applicable European, American and Japanese regulations.



Climatic chamber  
(-35°C to +60°C)  
14,3×10,1×4,3 m

[RETURN](#)





## Emissions R&D and emissions / drivability calibration tests for cars, vans & motorcycles

- Including continuous analysis of diluted and undiluted exhaust, tests at various temperatures

## Aftertreatment system tests:

- Periodic emissions tests during mileage accumulation or accelerated aftertreatment system ageing
- Cold start emissions tests at low ambient temperature
- Evaluations of aftertreatment system effectiveness over various driving cycles using continuous analysis of undiluted exhaust
- Long-term evaluations of Diesel / gasoline particulates filters
- OBD programmes to detect emissions control system failure

## Lube oil and fuel tests:

- Comparative tests on various fuels (standard, regional, alternative, liquid & gaseous)
- Investigations of fuel quality/contaminants and their impact on aftertreatment systems and exhaust emissions
- Tests on fuel additives and new engine/ gearbox oil formulations for enhanced fuel economy and reduced emissions



Chassis dyno facilities for vehicles with ICE and hybrid powertrains

## Chassis dyno certification and COP:

- For category M and N vehicles running on all fuel types
- WLTP, NEDC and Japan TRIAS test procedures and methods
- Additional activities: road load matching, wheel power measurements, additional tests required by Regulations 2017/1151, No. 83, etc.

[RETURN](#)





## 2 x Emissions Testing Laboratories (including 4x4 and climatic chamber and accompanying rooms)

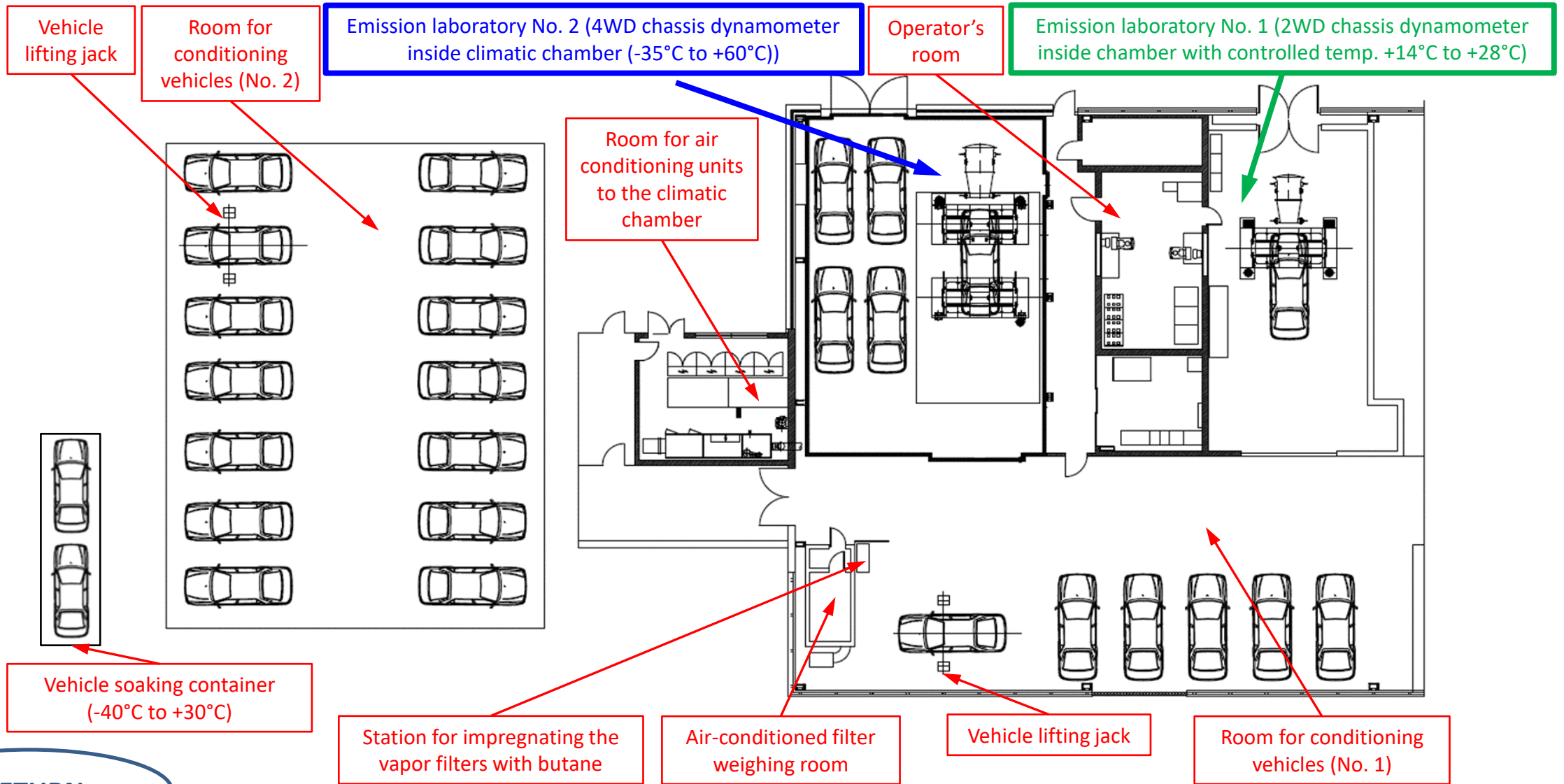

[RETURN](#)



## Vehicles with ICE and hybrid powertrains testing

Two Euro 6d-compliant test laboratories enabling the full range of certification and COP activities in the field of exhaust emissions



### Full range of required test types:

- Type 1 test (emissions after a cold start - WLTP, NEDC, JC08); including road load matching (coastdown) and RCB (for WLTP) and OBFCM
- Type 2 test (CO emissions at engine idle)
- Type 3 test (engine crankcase emissions)
- Alternative procedure for Type 4 test (COP evaporative emissions test, as defined by customer)
- Type 5 test (alternative procedure based on DFs from Euro 6 legislation, or as defined by customer)
- Type 6 test (emissions after a cold start at -7°C, currently only UDC required, but fully WLTP-capable for future requirement)
- Customer-specific verifications: OBD monitoring checks, verification of powertrain components related to emissions control

### Additional infrastructure:

- Temperature-controlled soak facilities for 25+ vehicles
- Workshop facilities
- RDE-compliant PEMS systems for future COP requirements



[RETURN](#)





# ENGINE TESTING

18 engine test cells:

- 8 fully dynamic test benches with power range from 250 kW to 560 kW, 3 benches equipped with e-storage
- 10 eddy-current test benches with power range from 10 kW to 470 kW

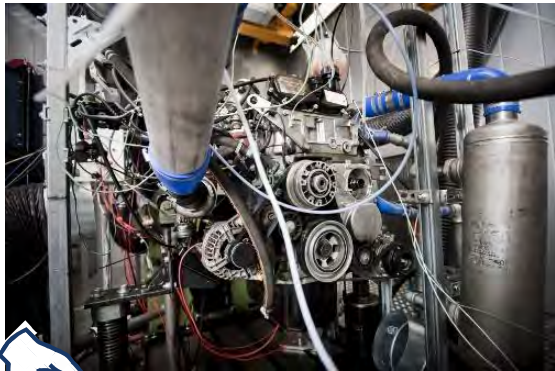

## Legend

- Dynamic dyno
- Medium/Heavy Duty dynamic dyno
- Test cells with CNG installation
- Test cells with LPG installation
- Development test cells
- Hydrogen (available by the end of 2024)

[RETURN](#)





## Engine, hybrid powertrains, electric motors testing and development

HD On-Road Engines

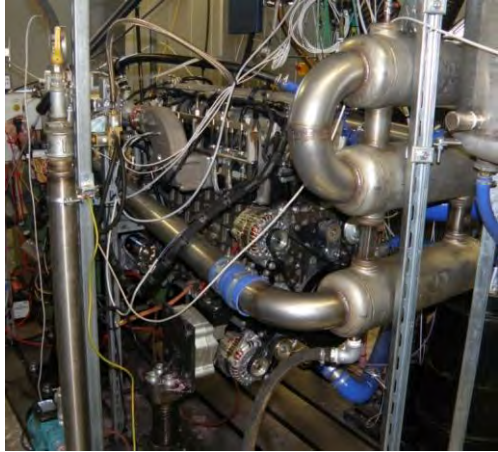

HD Non-Road Engines



Marine Recreational Engines

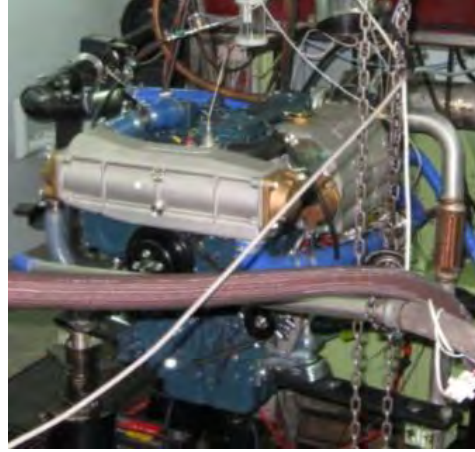

Industrial Engines



Hand held Engines



Automotive LD Engines



Hybrid Powertrains



Electric motors

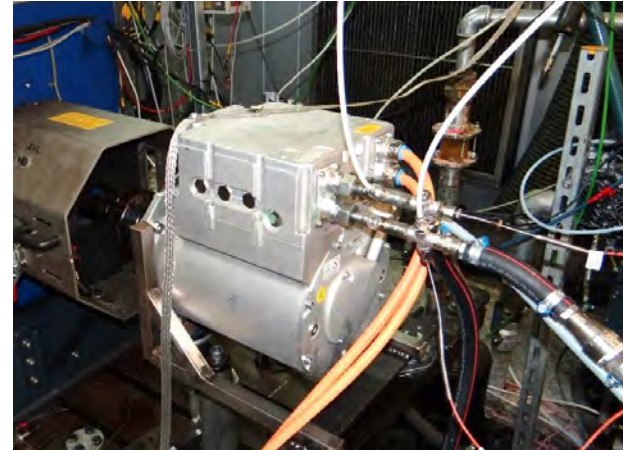

High Performance Engines



[RETURN](#)





## Engine development and testing:

- Base engine development (Euro 6d, post Euro 6)
- Combustion analysis
- Engine mapping and calibration - simulation of RDE on the engine dyno
- Engine vibration measurements
- Engine noise measurements
- Engine component temperature measurements
- Aftertreatment system development and optimisation (TWC, DOC, DPF, SCR, LNT, GPF)
- Engine parts and assemblies qualification
- Engine validation
- Support in launching new engines into production
- Development of engines for alternative (special) fuels and for new markets
- Support in qualification of parts from new suppliers
- Support in product development
- Quality and COP tests
- Type approval tests



## Engine durability and reliability tests:

- Global Engine Durability tests
- Engine component validation tests
- Customised procedures for specific test requirements

## Engine thermal tests:

- Thermal Cycle
- Thermal Mapping Test
- Heat Rejection Test
- Piston Temperature Distribution Test

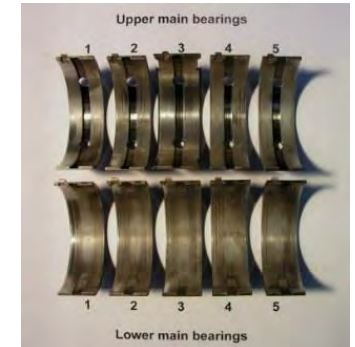

## Lube oil and fuel tests:

- Friction Losses Test
- Special Fuel Tests
- Biofuel Tests
- Engine Oil Validation Test
- Fuel Economy Test
- Fuels, fuel additives tests
- Alternative fuels (FAME, HVO, ethanol, fuel blends, CNG, LPG, H<sub>2</sub>...)
- Fuels for specific markets (Asia, USA, Brasil, others)



[RETURN](#)



## MD/HD/hybrid/electric testing



### Fully Dynamic AC Dyno:

- DynoExact 504/5 Px - 500kW/3000Nm – 5 000 rpm
- DYNOFORCE ASM 3000/1.8-4.5 - 560kW/3000Nm -4500rpm
- DYNOFORCE ASM 1200/3.6-10 – 450kW/1200Nm-10 000rpm

### Automotive electric motor testing

- Measurements of motor performance:  $T = f(n)$ ,  $P = f(n)$ ,
- Net max. power output measurements
- 30-minute power measurements

## AVL E-STORAGE

A high-voltage bi-directional DC source / sink unit that is optimized for characterization and verification of electric driveline components for automotive, off-highway, marine and aviation applications.

- Nominal capacity: 160 kW
- Output voltage: 8 ... 800 VDC
- Output current: up to 600 A
- Battery model simulation

### + 2nd:

- Nominal capacity: 250 kW
- Output voltage: 8-800 VDC
- Output current: 600 A

### Regatron Low Voltage Battery Emulator:

- Nominal capacity (max): 20 kW
- Output voltage (max): 65 V
- Output current (max): 385 A
- Portable unit (mobile usage)

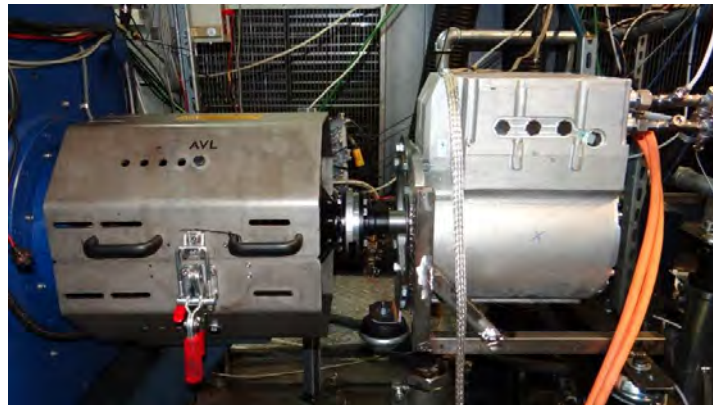

### Test bench software functionalities:

- iGEM
- ISAC
- InMotion
- AVL PUMA OPEN 1.5.5



Power analyzer (Yokogawa unit)



[RETURN](#)





## **BOSMAL provides a wide range of services on up-to-date and future powertrain technologies:**

- Light Duty (IC-engines, Hybrids (Mild to PHEV), Electric, Hydrogen)
- Heavy Duty (Diesel, CNG, Hybrid, Hydrogen)
- Marine & Stationary (Diesel, CNG, Biogas)

## **The scope of the activities on powertrains:**

- development tests and measurements
- durability / validation
- homologation / type-approval
- conformity of production
- fuel & lube oil tests
- benchmarking

## **Chassis dyno facilities for vehicles with ICE, hybrid, alternative powertrains**

Two Euro 6d-compliant test facilities enabling full range of certification and R&D activities in the field of emissions

## **Exhaust gas emissions tests on vehicles in the real driving conditions (RDE) using Portable Emissions Measurement Systems (PEMS)**

## **Emissions R&D and emissions/ drivability calibration tests for cars, vans & motorcycles**

- Including modal analysis of emissions, tests at various temperatures



in climatic chamber  
(-35°C to +60°C) 14,3×10,1×4,3 m



[RETURN](#)



## Dynamic transmission test bed for both manual, automatic transmissions and eDrive – drivetrain testing

- Suitable for both manual, automatic transmission and eDrive – drivetrain testing activity
- Durability and dynamic tests of transverse 4x2 drive systems
- Simulation of road load, vehicle, engine, driver, vehicle brake and starter
- Control of vehicle speed via accelerator pedal and vehicle brake (acceleration and deceleration)
- Simulation of various driving behavior (sporty, economic behavior, ...)
- Simulation of various driving situations (starting from rest, acceleration, deceleration, hill driving, coast down)
- Vibration spectrum analysis with **Reilhofer deltaAnalyser**



eDrive gearbox testing

eDrive drivetrain testing with 250kW emulator

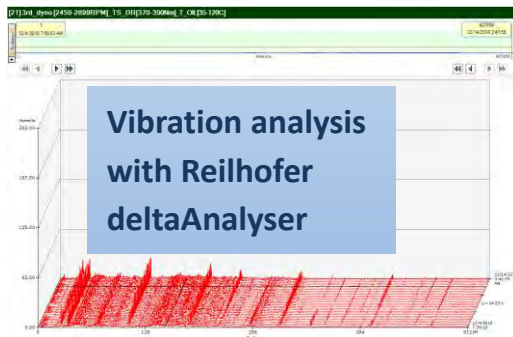

## Steady state transmission test bed for manual transmissions

- Suitable for manual transmissions testing
- Steady state durability tests of transverse 4x2 drive systems
- Vibration spectrum analysis with Reilhofer delta Analyser

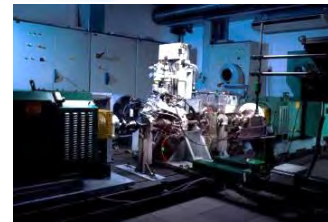

[RETURN](#)





## Scope of Accreditation of the Testing Laboratory No. AB 128

Issued by: POLISH CENTRE FOR ACCREDITATION. Issue No. 22B, date of issue 6<sup>th</sup> June 2023

The scope of Accreditation covers methods from the following fields:

AB 128	BOSMAL AUTOMOTIVE RESEARCH AND DEVELOPMENT INSTITUTE LTD TESTING LABORATORY
Identification Code of domain/object (objects) of tests:	Field of testing and item
A/6; A/8; A/26	Acoustic and vibration tests of electrical products and equipment, construction products and equipment, vehicles
C/4; C/8; C/9 C/10, C/12; C/13; C/21; C/23; C/26; C/45; C/46	Chemical tests of chemical products, construction products and materials, air, fuels, glass and ceramics, construction products and materials, machinery and devices, plastic and rubber products, textiles and leather, vehicles, paints and varnishes, lubricating materials
E/6; E/26; E/34; E/35; E/54	Electric and electronic tests of electrical and electronic products and vehicles
F/6; F/54	Electromagnetic compatibility (EMC) tests of electrical, and electronic products and equipment
G/6; G/8; G/13; G/21; G/23; G/45; G/54	Tests concerning environmental engineering of electrical and electronic equipment, construction products and materials, machinery and devices, plastic and rubber products, textiles and leather, paints and varnishes
H/6; H/21; H/23	Fire tests of electrical products and equipment, plastic and rubber products, textiles and leather
J/6; J/8; J/21; J/23; J/26; J/45	Mechanical tests, metallographic tests of construction products and materials, plastic and rubber products, textiles and leather, paints and varnishes and vehicles
L/6; L/8; L/17; L/21	Non-destructive testing of metal products and materials, electrical products and equipment, construction products and materials, other products, plastic and rubber products
N/6; N/8; N/10; N/12; N/13; N/19; N/21; N/23; N/26; N/35; N/45; N/46; N/54	Tests of physical properties of electrical and electronic equipment, construction products and materials, glass and ceramics, plastic and rubber products, personal protection equipment, fuels, textiles and leather, paints and varnishes, lubricating materials and vehicles
Q/21; Q/23	Sensory tests of plastic and rubber products, textiles



Accreditation Certificate of Testing Laboratory No AB 128 confirms that BOSMAL meets requirements of the PN-EN ISO/IEC 17025:2018-02 standard



AB 128

Detailed scope of Accreditation of the Testing Laboratory No. AB 128 see: [www.bosmal.com.pl](http://www.bosmal.com.pl)



**RETURN**



### PCBC Certificate AQAP 2110:2016 NATO requirements for quality assurance in design, development and manufacture No. A-73/1/2021

System in the following scope of activities: **research, laboratory testing, development and implementation, engineering services, technical consulting, training, design, development, manufacture, distribution and service in the field of transport and their equipment** is in conformance with the standard **AQAP 2110:2016**

Certificate AQAP 2110:2016 PCBC Nr A-73/1/2021 is valid from 10.08.2021 do 09.08.2024. From September 10, 2021, a certification unit changed from CCJ to PCBC. Previous certificates: since 26.10.2015 - Certificate AQAP 2110:2009 CCJ WAT Nr 1124/A/2015, and since 10.08.2018 – Certificate AQAP 2110:2016 CCJ WAT Nr 1124/A/2018.



### PCA Accreditation Certificate of Testing Laboratory No. AB 128 BOSMAL laboratory meets requirements of the PN-EN ISO/IEC 17025:2018-02 standard. Accredited activities are defined in **the Scope of Accreditation No. AB 128**



AB 128



### TDT Certificate of Approval No. 4 022 2010 L

This is to confirm that Testing Laboratory fulfilling the criteria of the standard PN-EN ISO/IEC 17025:2018-02 granted approval on conducting tests a range listed enclosure for: certification body TDT-CERT



4 022 2010 L







### PCBC Certificate No. JBS-199/4/2021

System in the following scope of activities:  
**design, testing and production of components for vehicles and their equipment, as well as test station and equipment for research and production** is in conformance with  
**PN-EN ISO 9001:2015-10, PN-ISO 45001:2018-06 and PN-EN ISO 14001:2015-09**



### IQNet Certificate of Integrated Management System No. PL-JBS – 199/4/2021

In the following scope of activities:  
**design, testing and production of components for vehicles and their equipment, as well as test station and equipment for research and production** system fulfills the requirements of the following standards:  
**PN-EN ISO 9001:2015-10, PN-ISO 45001:2018-06 and PN-EN ISO 14001:2015-09**



### TISAX label

Assessment of the BOSMAL for compliance with the **VDA-ISA** requirements, which includes the key security features of **ISO 27001** standard and additional criteria that relate to the automotive sector. The results of the assessment are available on the ENX platform:  
<https://portal.enx.com/en-US/TISAX/tisaxassessmentresults>



SCOPE-ID: ST38TZ  
<https://enx.com/tisax>





# CUSTOMERS' RECOMMENDATIONS AND ACCREDITATIONS

## Recommendation of Stellantis:



- for BOSMAL's tests in range of qualitative qualification of parts and assemblies to final assembly in Fiat manufacturing plants in Poland



**Acceptance of Volvo Car Corporation** for BOSMAL interior emission tests (formaldehyde acc. to VCS 1027,2739 and fogging acc. to VCS 1027,2719)



**Accreditation of Swiss Federal Office for the Environment (FOEN)** for BOSMAL as testing laboratory for tests according to the Swiss Federal Ordinance on Air Pollution Control (OAPC)



- for BOSMAL to carry out certain laboratory test work for Opel Plants



**BOSMAL LABORATORY APPROVAL FROM VOLKSWAGEN GROUP** - BOSMAL certified to perform material testing for Volkswagen Group suppliers with the negative Material Sampling Performance as per VW 52000 Standard. List of laboratories certified by the VW Group - on Volkswagen Group platform: [ONE.Konzern Business Plattform \(ONE.KBP\)](#)

**Acceptance of VOLKSWAGEN Group** for BOSMAL laboratory for emission tests required by VW 50180: standards PV3015 (fogging), PV3341 (VOC, headspace), PV3925 (formaldehyde, UV/VIS or HPLC), PV3900 (odour) and PV3942 (VOC, chamber emission tests).

**Acceptance of BMW** for BOSMAL laboratory for emission tests required by standards: VDA270 (odour), VDA278 (VOC and FOG, thermodesorption), GS97014-2 (CARB-Test, CARB-Screening), AA-0061 (formaldehyde and acetaldehyde, HPLC)

**Award for the best supplier of the year 2018 in the Engineering Services category of "FCA EMEA AWARD 2018"**



## Certificate of Business Credibility

BOSMAL - awarded for the highest evaluation of company stability in 2018 according to Bisnode Polska sp. z o.o.



## Membership



Polish Cluster of Composite Technologies



Polish Scientific Society of Combustion Engines



Klub Polskich Laboratoriów Badawczych POLLAB



**PKN**  
(Polish Committee for Standardization)

[RETURN](#)





- **SCOPE OF ACCREDITATION OF THE TESTING LABORATORY NO. AB 128**
- **CERTIFICATES, RECOMMENDATIONS, AWARDS AND DISTINCTIONS**
- **CONTACT – [kam@bosmal.com.pl](mailto:kam@bosmal.com.pl), +48 33 8130 544, +48 33 8130 462**

## We welcome your business

- Vehicle testing
- Sort testing
- Rde testing
- Exhaust emission and fuel consumption test
- Conformity of production
- Engine testing
- Hybrid vehicles/ powertrains testing
- Electromobility
- Accreditation
- Certificates
- Customers' recommendations and accreditations



AB 128



SCOPE-ID: ST38TZ  
<https://enx.com/tisax>



4 022 2010 L



**RETURN**



**SEE MORE**  
**WWW**

**THANK YOU FOR YOUR ATTENTION**





MATERIAL TESTING

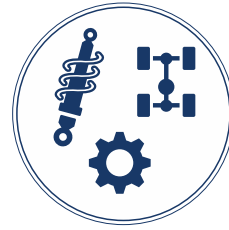

COMPONENT  
& ASSEMBLY TESTING



ROAD TESTING, EMISSION TESTING &  
ENGINE/POWERTRAIN TESTING

**BOSMAL**

**Prototyping, manufacturing, engineering  
& production automation**



PROTOTYPING, MANUFACTURING, ENGINEERING  
& PRODUCTION AUTOMATION



ENGINEERING  
SERVICES



HOMOLOGATION  
TYPE APPROVAL

[RETURN](#)

[SEE MORE](#)

[www](http://www.bosmal.co.uk)

50 years on the automotive market & 25 years as an Accredited Testing Laboratory AB 128



- Complex design and production services
- Design, analysis, prototyping and manufacturing
- Analysis & Simulation
- Tools and gauges - design & manufacturing
- Tooling, workshop aids and gauges - design & manufacturing
- Production of test stands, automated line sockets
- Metrological measurements
- Production capabilities
- Certificates
- Customers' recommendations and accreditations

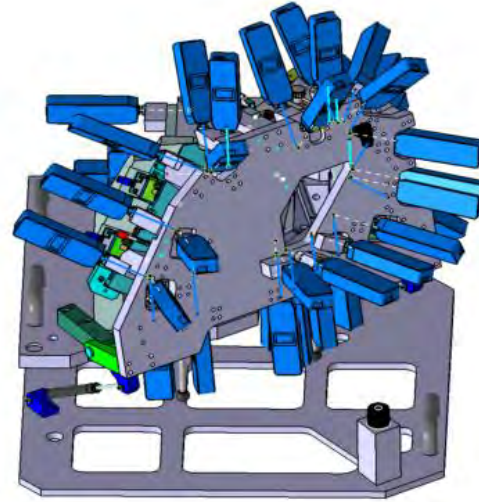

[RETURN](#)





### Complex design services - the range of offered services

#### Turnkey systems

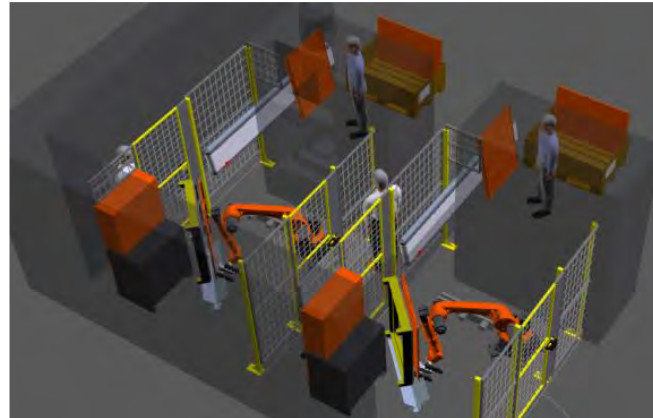
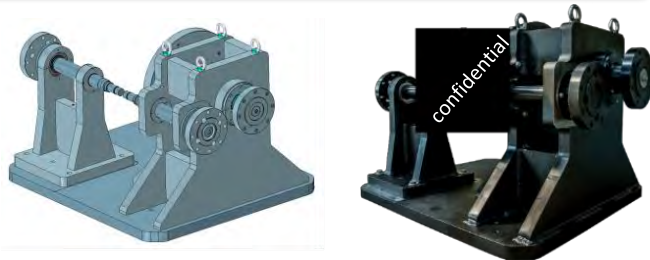
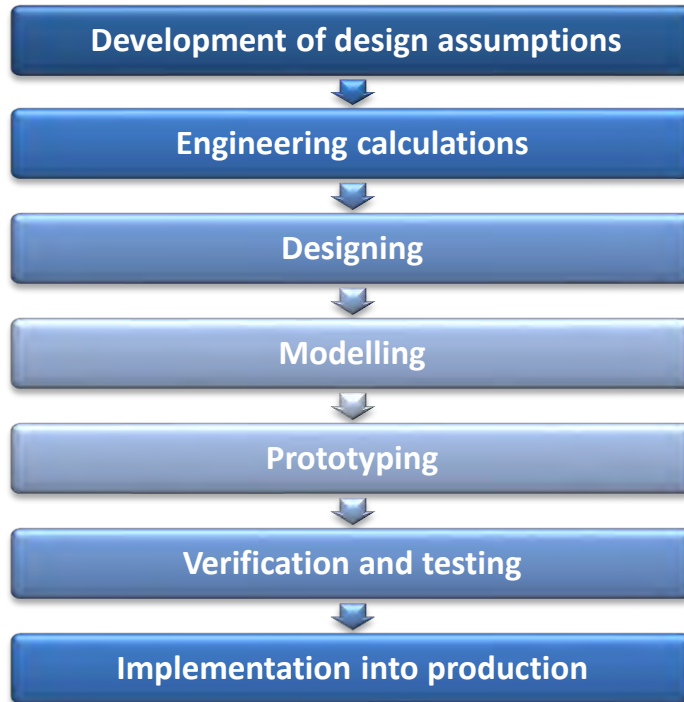

Example of concept, design and manufacturing of automated production line socket

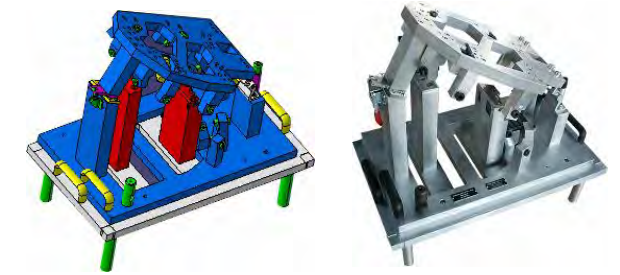
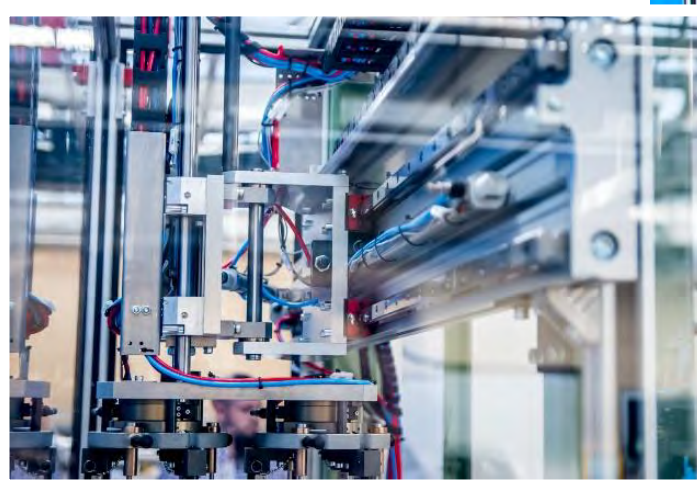

Control gauges design and production

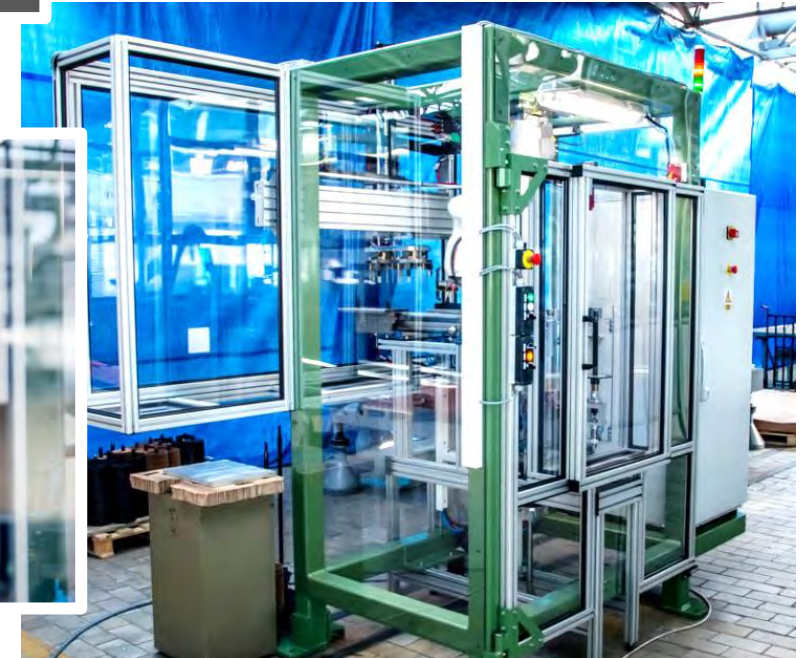

[RETURN](#)



## We are working on CAD/CAE/CAM software:

- Dassault Systemes CATIA V5
- Solid EDGE
- Siemens NX
- Autodesk INVENTOR
- SIEMENS NX CAM, Edge CAM
- Creo
- Autodesk AutoCAD
- Dassault Systemes Simulia ABAQUS, CATIA V5 Generative Assembly Structural Analysis

## Design

- 3D models
- 2D documentation
- Files format conversion

## Simulation /Calculation

Finite Element Analysis of issue:

- Static linear
- Static nonlinear
- Dynamic
- Modal (natural frequency)
- Frequency response
- Coupled field

## Manufacturing

- Milling
- Turning
- Grinding
- WEDM (wire electrical discharge machining)
- CMM validation



Control gauge for rearlight (DataMyte)

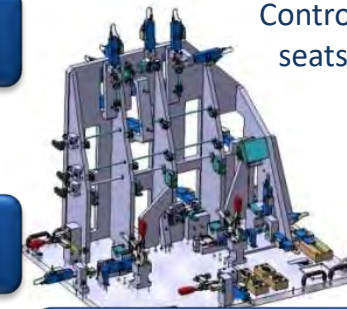

Control gauge for automotive seats structure verification

## As part of cooperation with manufacturers of the automotive and industrial industry, we develop:

- dimensional control gauges (jigs) standalone & for CMM
- laboratory gauges & equipment
- holders for vibration tests
- checking fixture (carpet, insulations)
- attribute gauges
- assembly device
- automated production cells, special machines
- mock-ups, prototypes
- workshop aids
- technological equipment of production lines
- control and measurement devices
- test stands for testing finished products

Complex development of testing instruments for components used in the automotive industry

Strength analysis

Programming advanced CAM system and CNC machining

[RETURN](#)





**Wide range of analysis performer for various industry area**

- fast strength analysis for part of control gauges
- simulation & optimisation of holders for vibration tests of part
- simulation & optimisation car luggage partitions for homologation
- simulation of rear underrun protection for homologation
- simulation of car special construction

**We perform analysis with support:**



Generative Assembly Structural

**RETURN**

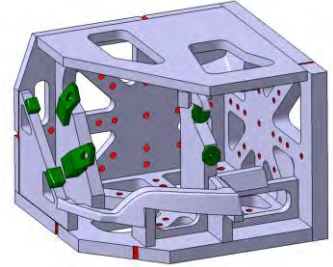

**3D model**

**Point mass representation for analysis**

**Vibration holder for automotive lightning industry - examples:**

- design according part and environment surface
- FEA model based on 3D design
- first natural frequency calculation
- response analysis
- optimisation of design to keep test requirements
- production documentation
- manufacture
- dimensional validation
- rigidity validation (vibration test)

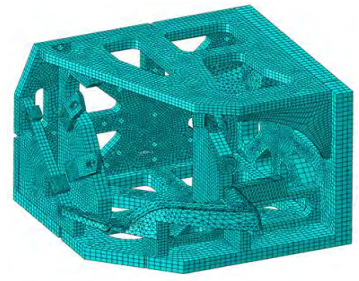

**Discretized model (MESH)**



**Vibration tests of automotive lightning carried out using manufactured holder**

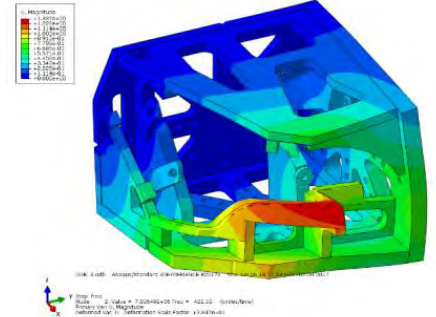

**Natural frequency of holder**

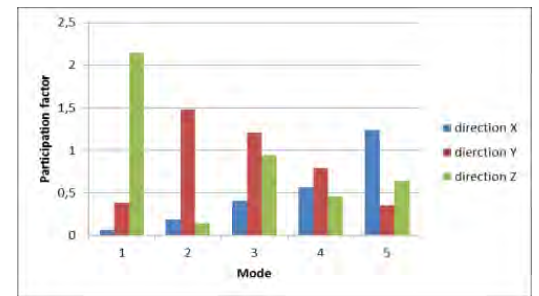

**Participation factor for first six modes**

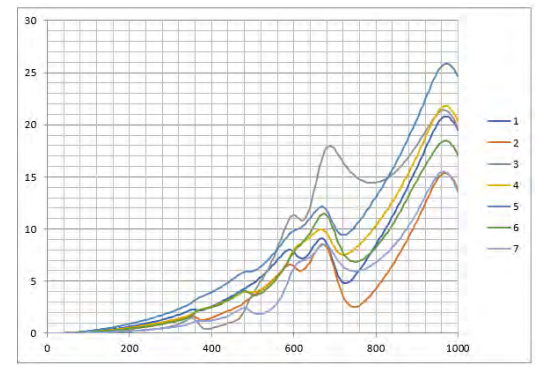

**Response function in frequency domain**



Our control and laboratory gauges, vibration holders are used to control and test:

- seals
- seats
- rugs, insulation, rear shelves (control templates)
- lamps
- mirrors
- wiper system
- car window
- radiator & fan system
- window lifting mechanism
- many other products

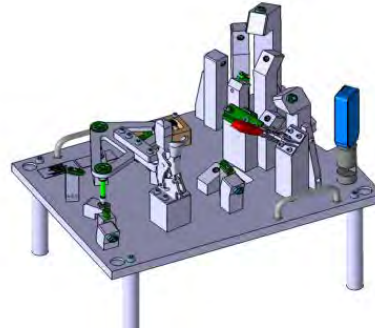

**Housing gauge  
for automotive lighting**

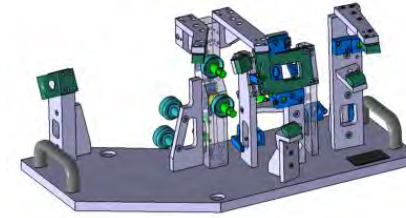

**3D/Photometry gauge for lamps**

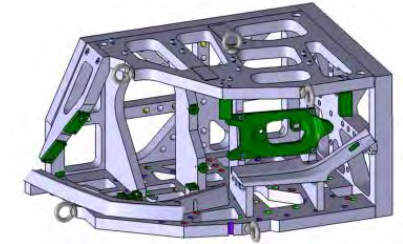

**Vibration holder for lamps**

Our automated production sockets are used for:

- optical control of part after manufacture
- automation of storing, collection and packaging of parts after manufacture

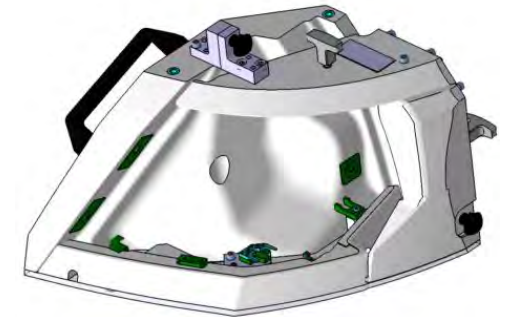

**Tightness & thermal gauge for lamps**

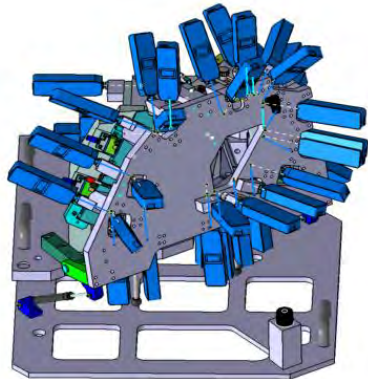

**Datamyte gauge  
for automotive lighting**

**Tools and gauges - design & manufacturing for automotive lightning industry  
- examples:**

- Dimensional Control gauges for components (housing, lens)
- Dimensional control gauge for lamp – Datamyte, 3D gauge
- Vibration test holder
- Photometry test gauge
- Sealing, Tightness & Thermal test gauge

Our test stands are used for:

- performing transmission tests
- checking the tightness of brake systems

[RETURN](#)





Control and measurement devices, test stands, automated production line sockets - examples of our implementations



Checking fixtures for automotive rugs/insulations control (left and right one)



Checking fixtures for automotive seats

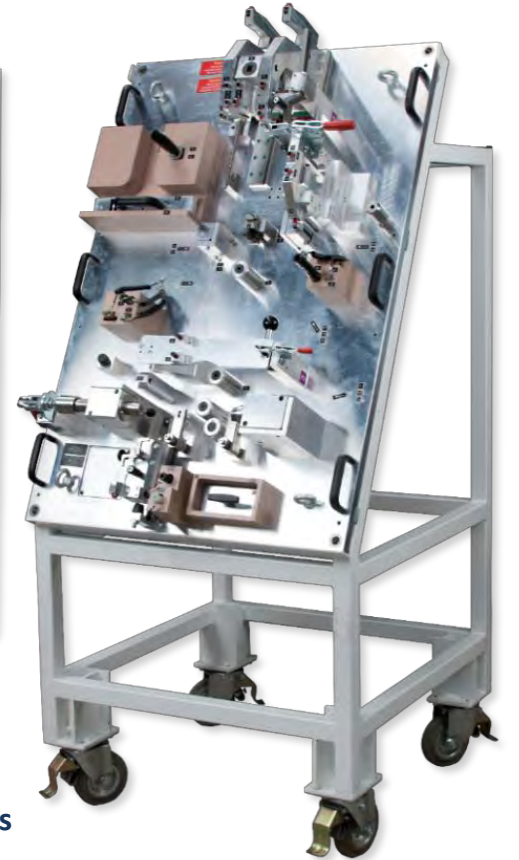

[RETURN](#)



Control and measurement devices, test stands, automated production line sockets - examples of our implementations

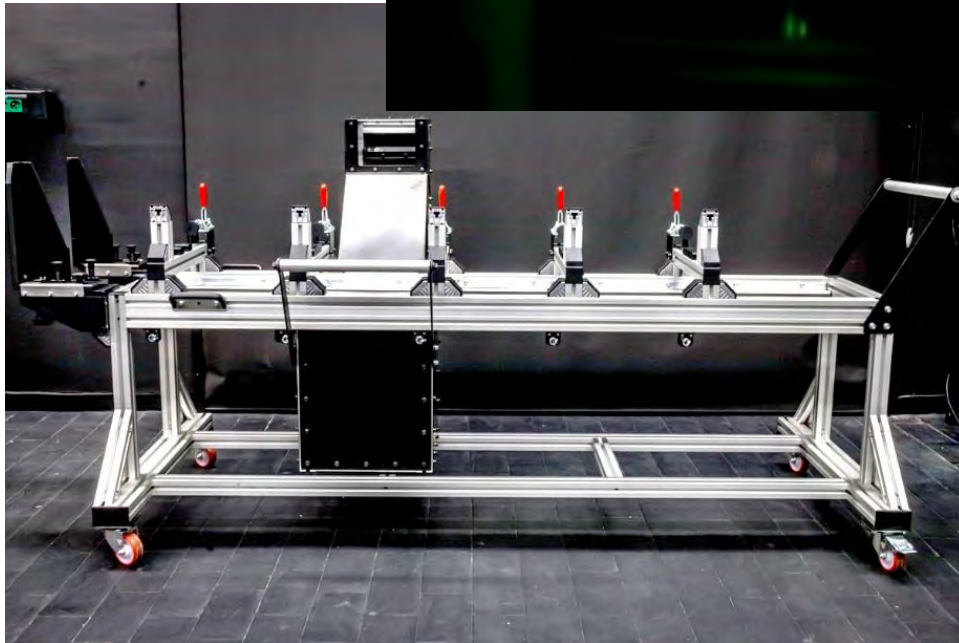
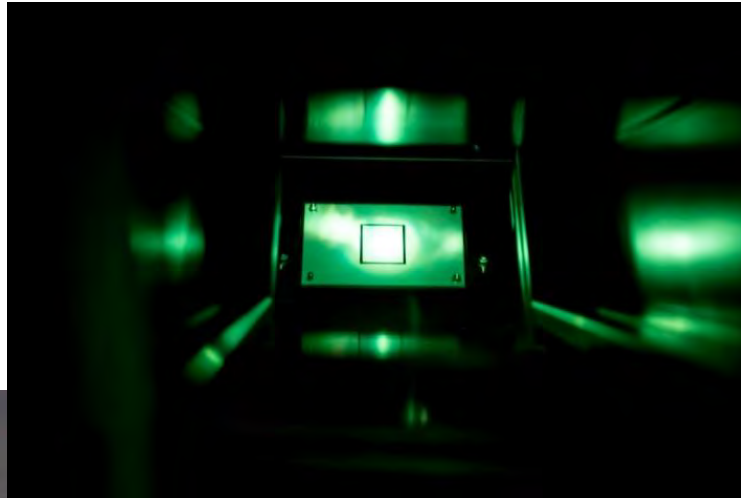

Test stand for testing and adjusting the light settings of railway signaling devices

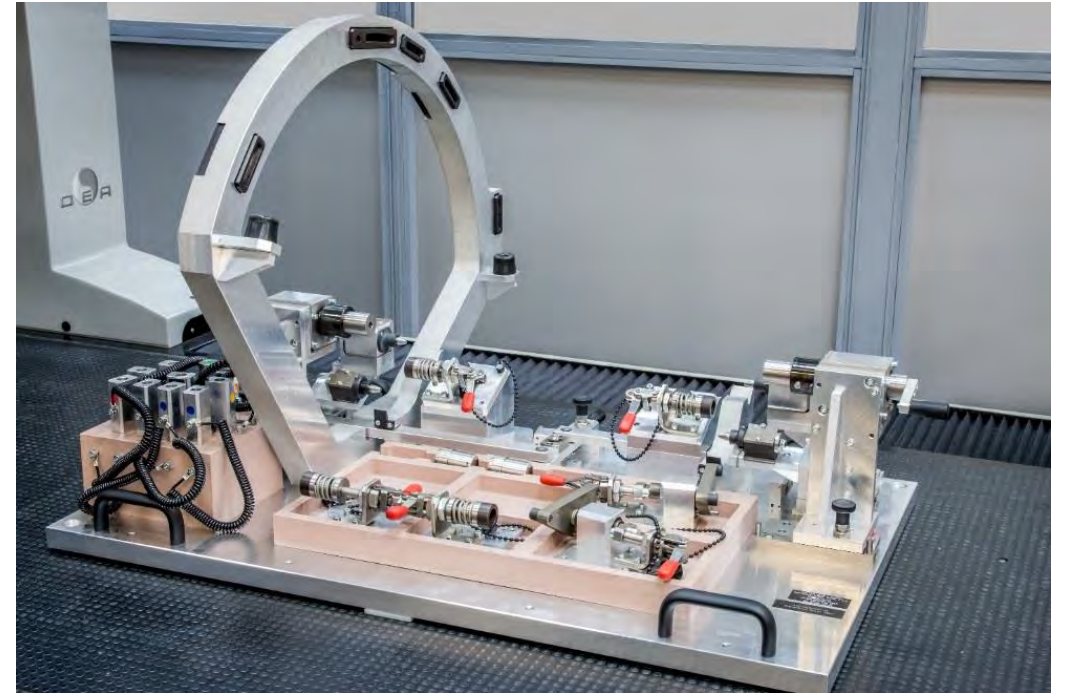

Test stand to control the swing angle of the car sittings



[RETURN](#)





Control and measurement devices, test stands, automated production line sockets - examples of our implementations

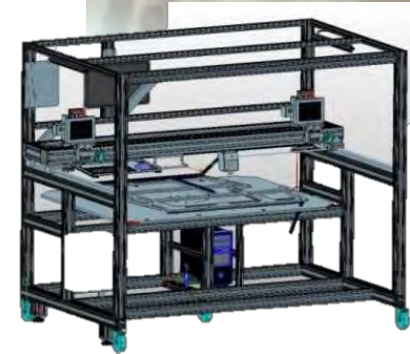

Non contact, optical device for the control of gaskets with automatic recording and data transmission



[RETURN](#)



## Control gauge with application for collecting measurements



### Application for collecting measurements

- efficient, durable, resistant to dirt and shocks tablet
- used technologies: wireless data transfer, PostgreSQL, VBA (alternatively Oracle, C #)

### Main functions:

- measurements collecting and processing
- tolerance modification
- measuring points compensation
- print report
- data archivisation
- data export
- adding user, positions, machines

[RETURN](#)





## Control and measurement devices, test stands, automated production line sockets

As part of cooperation with manufacturers of the automotive and industrial industry, we develop:

- control and measurement devices
- test stands for testing finished products
- automated line sockets,

Our team of constructors specializes in pneumatics, vacuum technology, robots application, control.

In our construction solutions we use pneumatic systems, programmable logic controllers (PLC), operator panels (HMI), electric motors with encoders.

Institute also undertakes solutions with the use of industrial robots and video cameras. Our constructions are manufactured in accordance with the latest EU requirements.



Non contact, optical device for the control of gaskets with automatic recording and data transmission



An example of a special stand designed to automate the production line socket

[RETURN](#)



## Design and production of control and measurement devices, test stands, automated production line sockets

INDUSTRY 4.0



- Energy consumption measurement systems
- Optimization of working times
- Data Acquisition
- SCADA Systems
- Monitoring and remote access
- Process management and optimization<sup>1</sup>
- Information flow management<sup>1</sup>
- External software integration
- Online content access security<sup>2</sup>

<sup>1</sup>NAZCA - APA Group

<sup>2</sup>Cyberus Key - CyberusLabs



[RETURN](#)

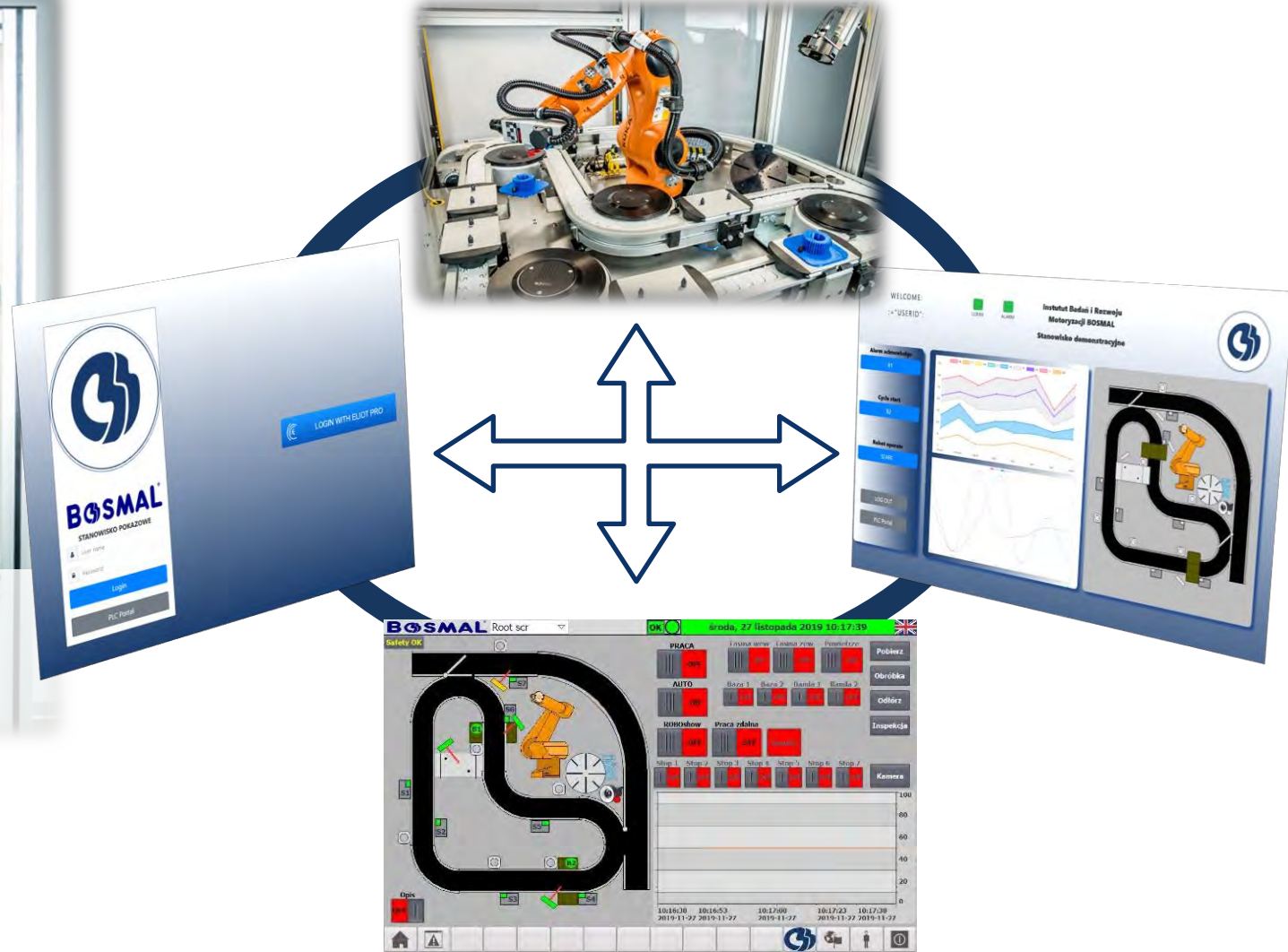





# PRODUCTION OF TEST STANDS, AUTOMATED LINE SOCKETS

Control and measurement devices, test stands, automated production line sockets - examples of our implementations

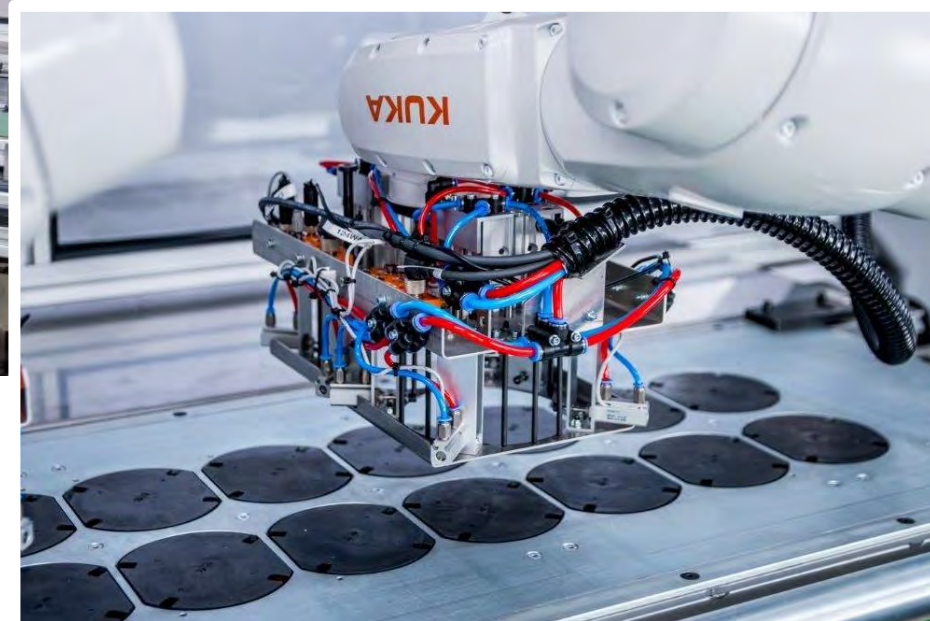
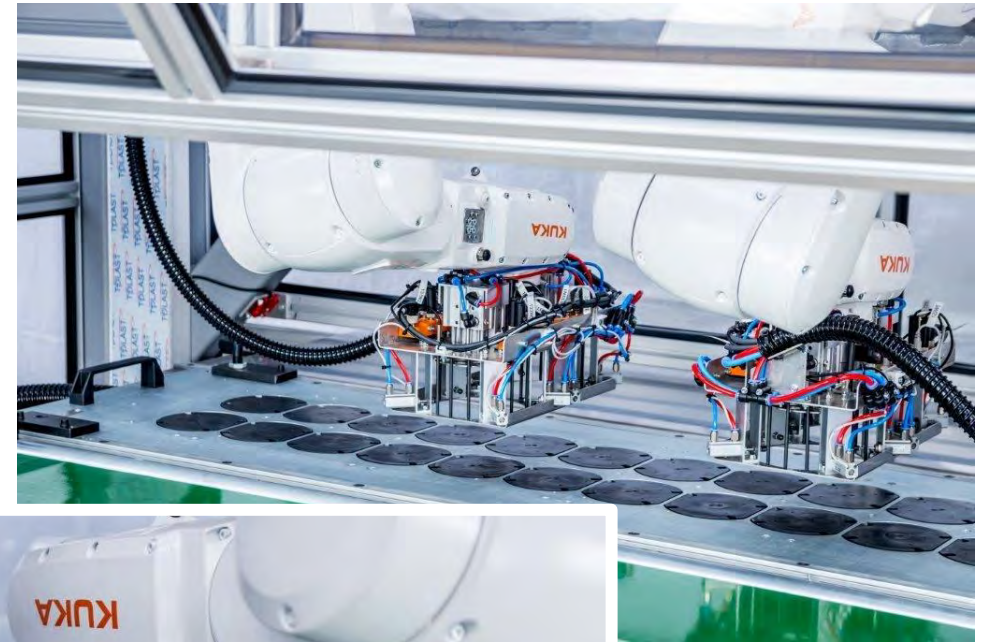

Example of special machine designed for automated production line socket







Rapid prototyping

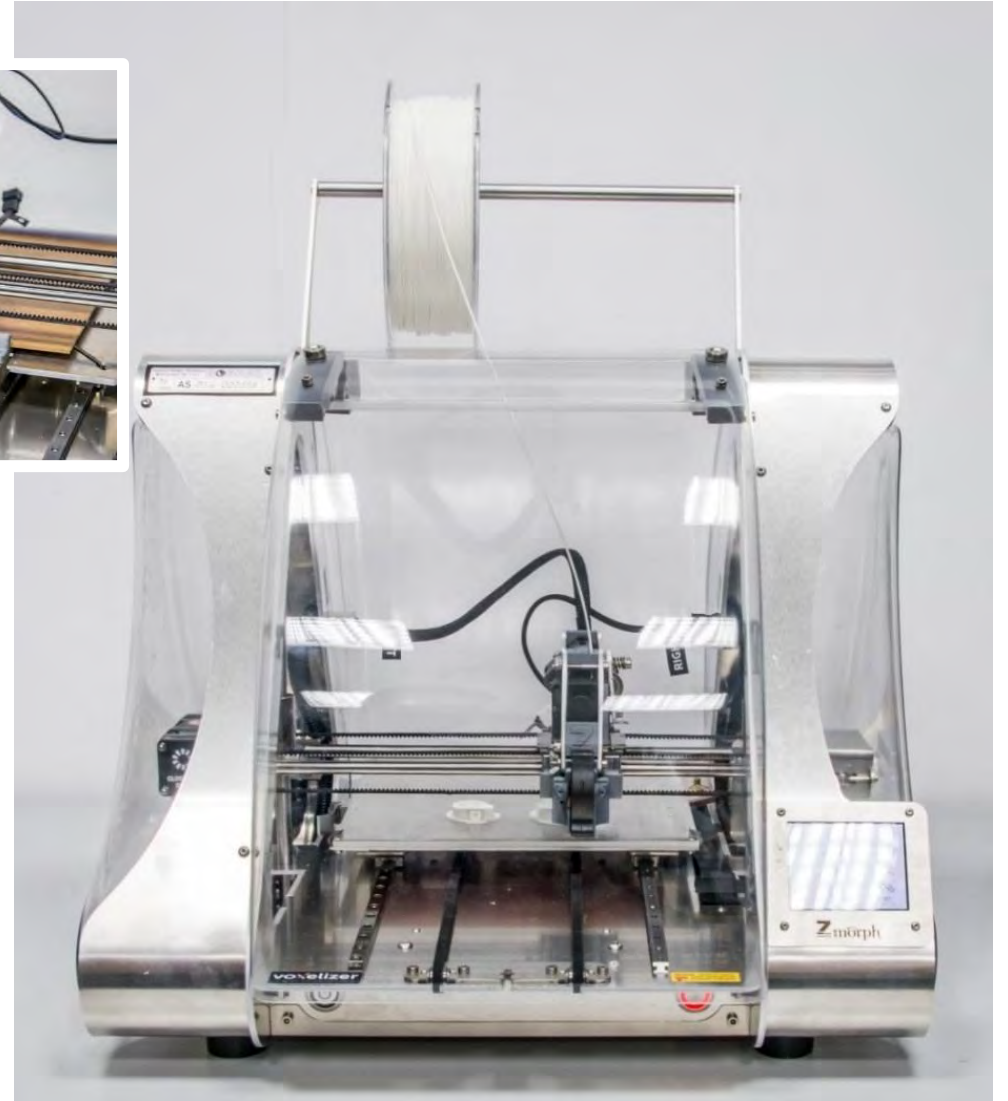
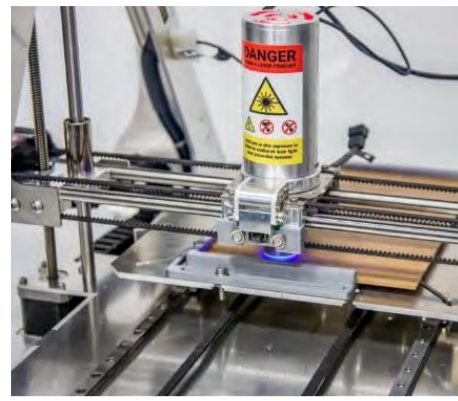

[RETURN](#)





**5-axis vertical machining centre -  
C250 HERMLE**

Table dimensions	450 x 360 mm
Max. table load	300 kg
Minimum dimensions:	
Travel on axis X	600 mm
Travel on axis Y	550 mm
Travel on axis Z	450 mm
Positioning accuracy	P≤0,008 mm



**5-axis vertical machining centre,  
REMA CONTROL - Leonard LT5 2.5**

Table dimensions	2720 x 820 mm
Rotating table dimensions:	
Built-in table diameter	800 mm
Rotational range of axis a	360°
Max. load of built-in table	2500 kg
Minimum dimensions:	
Travel on axis X	2550 mm
Travel on axis Y	1000 mm
Travel on axis Z	1000 mm
Positioning accuracy	+/- 0,008 mm
Repeatability accuracy	+/- 0,005 mm
Rotational range of axis b	+/- 105°



**3-axis vertical machining centre, AKIRA  
SEIKI - Performa Classic V4A**

Table dimensions	1200 x 480 mm
Max. table load	1300 kg
Minimum dimensions:	
Travel on axis X	1050 mm
Travel on axis Y	540 mm
Travel on axis Z	550 mm
Positioning accuracy	+/- 0,01 mm
Repeatability accuracy	+/- 0,003 mm



[RETURN](#)



## Wire cutter (EDM) - MITSUBISHI MV2400S Tubular

Travel on axes XYZ	600 x 400 x 310 mm
Max. workpiece dimensions	1050 x 820 x 305 mm
Max. workpiece weight	1500 kg
Max. bath fill depth	305 mm
Table dimensions	840 x 560 mm
Max. cut angle	degrees $\pm 15^\circ$ / 260 mm degrees $\pm 30^\circ$ / 110 mm
Wire used	0,10 – 0,30 mm
Automatic wire threading for wires of diameter	0,10 – 0,30 mm
Max. weight of wire spool	10 kg



## Opal Waterjet 2D cutting machine

Utilisation of waterjet cutting allows work with a wide variety of materials such as: stone, wood, various steel grades, non-ferrous metals, plastics etc.

Dimensions of the table working surface	1500x3000 mm
Cutting thickness	0,5 - 150 mm



[RETURN](#)





## 5-axis CNC milling machine (work table 4000mm x 2700mm)

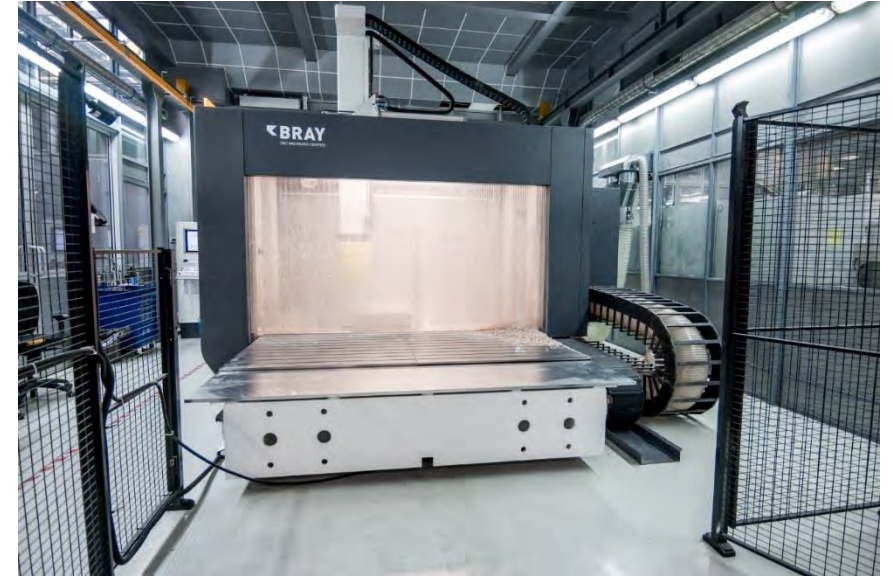
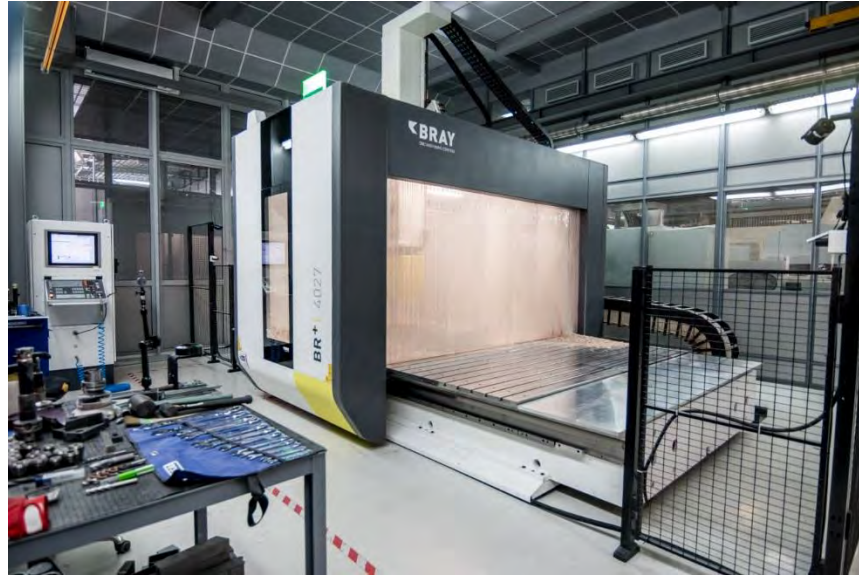

Dimension of the work surface	4000 x 2700 x 1480 mm
The maximum dimension of the workpiece 3X	3974 x 2684 x 1168 mm
The maximum dimension of the workpiece 5X	3166 x 2086 x 1060 mm
The total dimension of the machine	7070 x 4870 x 4810 mm
The maximum speed in the axis	60/30/30 m/min
Repeatability in the XYZ position	$\pm 0,01$ ( $\pm 0,015$ ) mm
XYZ positioning accuracy	$\pm 0,02$ ( $\pm 0,035$ ) mm/m



[RETURN](#)



## High precision geometrical measurements (contact and contact-free)

- Linear and angular dimensions
- Measurements of shape and position deviations
- Presentation of surface topography
- Surface roughness assessment



**OPTIV CLASSIC 321GLTP**



**DEA GLOBAL STATUS**



**Hexagon (ROMER)  
Absolute Arm 87 serie**



**DEA GLOBAL PERFORMANCE  
1200 X 3000 X 1000 mm**

### Measuring machines:

- DEA GLOBAL PERFORMANCE (12.30.10) with measurement and inspection software PC-DMIS™ CAD++ On-line with DCT CATIA V5 and DCT UNIGRAPHICS
- DEA GLOBAL STATUS (09.15.08)
- HexMet-OPTIV CLASSIC 321GL tp
- Hexagon (ROMER) Absolute Arm 87 serie



[\*\*RETURN\*\*](#)





### PCBC Certificate AQAP 2110:2016 NATO requirements for quality assurance in design, development and manufacture No. A-73/1/2021

System in the following scope of activities: **research, laboratory testing, development and implementation, engineering services, technical consulting, training, design, development, manufacture, distribution and service in the field of transport and their equipment** is in conformance with the standard **AQAP 2110:2016**

Certificate AQAP 2110:2016 PCBC Nr A-73/1/2021 is valid from 10.08.2021 do 09.08.2024. From September 10, 2021, a certification unit changed from CCJ to PCBC. Previous certificates: since 26.10.2015 - Certificate AQAP 2110:2009 CCJ WAT Nr 1124/A/2015, and since 10.08.2018 – Certificate AQAP 2110:2016 CCJ WAT Nr 1124/A/2018.



### PCA Accreditation Certificate of Testing Laboratory No. AB 128

BOSMAL laboratory meets requirements of the **PN-EN ISO/IEC 17025:2018-02** standard.

Accredited activities are defined in **the Scope of Accreditation No. AB 128**



AB 128



### TDT Certificate of Approval No. 4 022 2010 L

This is to confirm that Testing Laboratory fulfilling the criteria of the standard **PN-EN ISO/IEC 17025:2018-02** granted approval on conducting tests a range listed enclosure for: certification body **TDT-CERT**



4 022 2010 L



[RETURN](#)



### PCBC Certificate No. JBS-199/4/2021

System in the following scope of activities:  
**design, testing and production of components for vehicles and their equipment, as well as test station and equipment for research and production** is in conformance with  
**PN-EN ISO 9001:2015-10, PN-ISO 45001:2018-06 and PN-EN ISO 14001:2015-09**



### IQNet Certificate of Integrated Management System No. PL-JBS – 199/4/2021

In the following scope of activities:  
**design, testing and production of components for vehicles and their equipment, as well as test station and equipment for research and production** system fulfills the requirements of the following standards:  
**PN-EN ISO 9001:2015-10, PN-ISO 45001:2018-06 and PN-EN ISO 14001:2015-09**



### TISAX label

Assessment of the BOSMAL for compliance with the **VDA-ISA** requirements, which includes the key security features of **ISO 27001** standard and additional criteria that relate to the automotive sector. The results of the assessment are available on the ENX platform:  
<https://portal.enx.com/en-US/TISAX/tisaxassessmentresults>



SCOPE-ID: ST38TZ  
<https://enx.com/tisax>



[RETURN](#)





# CUSTOMERS' RECOMMENDATIONS AND ACCREDITATIONS

## Recommendation of Stellantis:



- for BOSMAL's tests in range of qualitative qualification of parts and assemblies to final assembly in Fiat manufacturing plants in Poland



**Acceptance of Volvo Car Corporation** for BOSMAL interior emission tests (formaldehyde acc. to VCS 1027,2739 and fogging acc. to VCS 1027,2719)



**Accreditation of Swiss Federal Office for the Environment (FOEN)** for BOSMAL as testing laboratory for tests according to the Swiss Federal Ordinance on Air Pollution Control (OAPC)



- for BOSMAL to carry out certain laboratory test work for Opel Plants



**BOSMAL LABORATORY APPROVAL FROM VOLKSWAGEN GROUP** - BOSMAL certified to perform material testing for Volkswagen Group suppliers with the negative Material Sampling Performance as per VW 52000 Standard. List of laboratories certified by the VW Group - on Volkswagen Group platform: [ONE.Konzern Business Plattform \(ONE.KBP\)](#)

**Acceptance of VOLKSWAGEN Group** for BOSMAL laboratory for emission tests required by VW 50180: standards PV3015 (fogging), PV3341 (VOC, headspace), PV3925 (formaldehyde, UV/VIS or HPLC), PV3900 (odour) and PV3942 (VOC, chamber emission tests).

**Acceptance of BMW** for BOSMAL laboratory for emission tests required by standards: VDA270 (odour), VDA278 (VOC and FOG, thermodesorption), GS97014-2 (CARB-Test, CARB-Screening), AA-0061 (formaldehyde and acetaldehyde, HPLC)

**Award for the best supplier of the year 2018 in the Engineering Services category of "FCA EMEA AWARD 2018"**



## Certificate of Business Credibility

BOSMAL - awarded for the highest evaluation of company stability in 2018 according to Bisnode Polska sp. z o.o.



## Membership



Polish Cluster of Composite Technologies



Polish Scientific Society of Combustion Engines



Klub Polskich Laboratoriów Badawczych POLLAB



**PKN**  
(Polish Committee for Standardization)

[RETURN](#)



- **SCOPE OF ACCREDITATION OF THE TESTING LABORATORY NO. AB 128**
- **CERTIFICATES, RECOMMENDATIONS, AWARDS AND DISTINCTIONS**
- **CONTACT** – [kam@bosmal.com.pl](mailto:kam@bosmal.com.pl), +48 33 8130 544, +48 33 8130 462

## We welcome your business

- **Complex design and production services**
- **Design, analysis, prototyping and manufacturing**
- **Analysis & Simulation**
- **Tools and gauges - design & manufacturing**
- **Tooling, workshop aids and gauges - design & manufacturing**
- **Production of test stands, automated line sockets**
- **Metrological measurements**
- **Production capabilities**
- **Certificates**
- **Customers' recommendations and accreditations**



SCOPE-ID: ST38TZ  
<https://enx.com/tisax>



**RETURN**

50 years on the automotive market & 25 years as an Accredited Testing Laboratory AB 128



**SEE MORE**  
**WWW**



**THANK YOU FOR YOUR ATTENTION**



MATERIAL TESTING

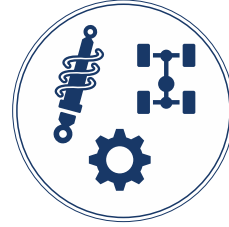

COMPONENT  
& ASSEMBLY TESTING



ROAD TESTING, EMISSION TESTING &  
ENGINE/POWERTRAIN TESTING

**BOSMAL**

**Engineering services**



PROTOTYPING, MANUFACTURING, ENGINEERING  
& PRODUCTION AUTOMATION



**ENGINEERING  
SERVICES**



HOMOLOGATION  
TYPE APPROVAL

RETURN

SEE MORE

WWW





## Staff augmentation (Body/ team leasing):

1. Rental of employees (including residents)
2. Auditors/ experts outsourcing
  1. System audits
  2. Product/ service audit
  3. Process audit
  4. Interim Management

## Special production

1. 3D Printing
2. Precision parts
3. Surface coating
4. Parts Machining – technologies
5. Injection Moulding

## Individual design

1. Body Systems
2. Exterior trim systems
3. Interior Trim Systems
4. New Product Development (NPD)
5. Modeling and engineering calculations
6. Draughting and Markup
7. Product analysis and optimization
8. 3D scanning and reverse engineering
9. Assembly design
10. Data Management
11. Materials

## Opinions, analyzes, trainings and workshops

1. Technical analyses and opinions
2. Opinions on innovativeness
3. Root cause analysis (RCA) of non-conformances of components and subassemblies
4. Verifications of the conformity of vehicle production with the producer's requirements,
5. Trainings on type-approval regulations and requirements
6. Workshops on material testing

## Development and optimization of processes in the company

1. Production processes simulation
2. Organization of purchases
3. Implementation and improvement of management systems
4. ERP/CAD/CAM/PLM systems
5. Production planning
6. Organization of the supply chain (logistics and warehouses)
7. Total Productive Maintenance (TPM)
8. Analysis and verification of manufacturing technology
9. Energy audits
10. Analysis and optimization of production and/or management processes



[RETURN](#)



## Rental of employees (including residents):

Body Leasing is a form of outsourcing involving the delegation of specialists to work for the client for a specific period of time. Body leasing competences are selected strictly in terms of the required knowledge and skills to implement a given project. During the cooperation, specialists can exchange, guaranteeing all the time matching of skills to the needs of the project.

Depends on the customer requirements we offer 3 levels of workers:

- Junior – for simple activities to support customer team – experience up to 2 years
- Specialist – for more specific tasks, not only support the team but also will behave proactively – experience 3-5 years
- Expert – for new solutions or special tasks like reorganization, audits etc. - more than 5 years of experience.

## Residents:

In particular, we offer engineering support by resident engineers in the following areas:

- car production
- engine production
- production of agricultural machinery



## Available residents:

- Designer
- Project Manager
- Maintenance Engineer
- Sales Engineer/Specialist
- IT Engineer
- Product Engineer
- Process Engineer
- Quality Engineer
- Purchasing Engineer/Specialist
- Logistics Engineer



[RETURN](#)





## Auditors/ experts outsourcing

- System audits
- Product/ service audit
- Process audit
- Zarządzanie tymczasowe (Interim Management)

### System audits:

Documentation and processes audit in accordance with the requirements of the quality system. Identifying areas for improvement and critical points

Audit conducted by an expert in the field of Quality or a certified Auditor of the Quality System

Audits according to:

- ISO 9001 (quality management system requirements)
- ISO 45001 (concerning occupational health and safety management systems)
- ISO 14001 (requirements for an environmental management system)
- IATF 16949 (defines the requirements for the quality management system in companies related to the automotive industry)
- ISO/IEC 27001 (regarding information security management systems)
- TISAX (regarding information security in the automotive industry)

### Product/ service audit:

Independent product quality assessment to determine its usability and compliance with the requirements. The criteria for such an audit are: production documentation, technical and functional specification of the product, customer requirements.

- According to VDA 6.5
- According to differently defined criteria

### Process Audit:

Process Audit - verification of compliance with the requirements of a given production process:

- process map verification
- checking process parameters from technology or work instructions
- data collection
- SWOT analysis (indication of strengths and weaknesses of the production process)
- quality control analysis

The process audit can be carried out according to various standards (eg VDA 6.3), depending on the requirements.

### Interim Management:

According to the Interim Management Association, “Interim Management is the rapid provision of senior executives to manage change or transition”. In simpler terms, an interim manager is a highly experienced and specialized executive whom you can employ for a short time to solve a specific business problem. He or she is a master project manager who will not only give you advice, but also implement your solution. In short, an interim manager meets your specialized needs, is more motivated to look out for your best interests, is actively involved from start to finish on achieving solutions, works with your own people and reports directly to you. He or she develops the strategies and then implements them.

### Dostępni eksperci-managerowie w zakresie:

- Procurement
- Engineering
- Lean Manufacturing
- SCM
- Quality



[RETURN](#)



## Body Systems

- Body panels and closures
- Body structure (underbody structure, crash system)
- Body panels (fender, engine bay, rear quarter, body side)
- Doors (side door, SLD, RCD)
- Closures (hood, tailgate, engine cover)
- Closure mechanisms
- Roof/ upper structure
- Glazing (windscreen, backlight, fixed, dynamic)
- Sealing

## Exterior trim systems

- Bumper systems
- Floors, under-trays, aero shields, diffusers
- Ducting, vents, grilles
- Exterior trim, finishers, wheel-arch liners
- Luggage bay trim
- NVH, heat shields, thermal management
- HVAC system, intakes, distribution
- Wipers/ washer systems
- Exterior mirrors
- Polymer/Composite body systems

## New Product Development (NPD)

Experience at phases:

- Concept development
- Engineering feasibility
- Prototype part development and release

## Interior Trim Systems

- Instrument Panels
- A-Pillar Trim, B-Pillar Trim, C-Pillar Trim
- Centre Consoles
- Handbrake
- Under-Seat Storage
- Headliners/Sun Visors
- Seating Systems
- Door Sills

## Modeling and engineering calculations

- Surface modeling
- Solid modeling
- Parametric modeling

## Draughting and Markup

- PMI (Product manufacturing information) and annotation
- Sections and auxiliary views
- GD&T ((Geometric dimensions and tolerances)
- SC/CC (Significant and Critical Characteristics)
- 2D draughting/annotation
- 3D functional tolerancing and annotation (FT&A)

## Product analysis and optimization

- Product analysis and verification
- Weight calculations (optimization of weight and quality according to product application)

## 3D scanning and reverse engineering

- Contact and non-contact measurements of components
- Measurement control of a finished product with 3D drawings
- 3D scanning of a component in order to build a 3D model (reverse engineering)

## Assembly design

- Building assemblies / BOM
- Annotations
- Named views
- Kinematic studies/ collisions / constraints

## Data Management

- Following part name, number, version & revision rules
- Data storage rules
- Import/export functions
- Change management
- Release process

## Materials

- Polymers & Composites
- Sheet metal (steel, aluminium)
- CFK
- SMC
- Plastic mould parts
- Fibber glass
- BIW Alu & SMC
- Casting (aluminium)
- Metal



[RETURN](#)





## 3D Printing

Application:

- prototyping (rapid prototyping)
- instrumentation and holders for special purposes
- product customization
- spare parts
- production of final parts (additive manufacturing)

Goals and benefits of 3D printing

- Cost & Time optimization
- Structural Optimization
- Additive Manufacturing (Industrial 3D Printing)
- Automotive Prototyping
- 3D Printing for Automotive
- 3D technology for welding devices
- Manufacturing support (devices, jigs & fixtures, production tools control)
- Control Gauges
- Research and Development
- Manufacturing support
- Low series parts
- Engineering support for Prototyping
- Architected Materials
- Optical quality control based on 3D scanning technology
- Reverse Engineering – 3D Scan
- Automotive CAD engineering
- Validation

## Precision parts

1. We initiate the project by collecting information about:
  - part application
  - planned lifespan
  - intended use of the part
2. Then we analyze and verify the technology
  - a.) We analyze the possibility of manufacturing a part according to the technology provided by the customer in terms of:
    - machining
    - availability of semi-finished parts
    - heat treatment
    - chemical coating
  - b.) If necessary, we develop a technology alternative to the existing oneThe proposal to use an alternative technology may result from:
  - availability of materials
  - chemical coating capabilities
  - possibility of cheaper solutions
  - endurance of particular solution
3. We develop target technology
4. We prepare a plan for the implementation of the production process



## Parts Machining – technologies

- CNC milling
- CNC turning
- Deep hole drilling and milling
- Grinding
- EDM + Electrodes making
- Bending
- Welding
- Laser welding
- Laser cutting

## Surface coating

- UV PVD Chromium
- UV PVD Nickel
- Electroless Nickel plating
- Electroless Chromium plating
- Metallization
- Part painting

## Injection Moulding

- Parts design and development
- Injection mould design
- Tooling for injection moulds
- Serial production of plastic parts
- Parts painting

[RETURN](#)



## Production processes simulation

Pre-start factory process simulations or optimization simulations of existing production / warehouse / transport solutions.

## Organization of purchases

- searching for potential direct and indirect suppliers
- audit of potential and implementation support for suppliers
- consulting and training in purchasing
- creating purchase categories - MoB analyses (Make or Buy)
- identification of human resources
- securing the supply chain (including developing and securing deliveries of materials for production)
- purchasing processes outsourcing
- implementation or support in the implementation of strategies, processes and procedures

## Implementation and improvement of management systems

- consulting and training
- training and implementation for ISO 9001 / IATF 16949 / ISO 14001 / ISO 45001 certification
- determination of human resources
- implementation or support in the implementation of strategies, processes and procedures

## ERP/CAD/CAM/PLM systems

- assistance in the selection and implementation of optimal solutions

## Production planning

- layout
- verification of needs for machines, equipment and processes
- implementation in accordance with Lean method
- training and consulting
- identification of human resources
- analysis of the selection of automatic and manual processes
- implementation or support in the implementation of strategies, processes and procedures

## Organization of the supply chain (logistics and warehouses)

- choice of appropriate solutions
- layout
- identification of human resources
- analysis of the process automation
- training and consulting
- processes verification
- implementation or support in the implementation of strategies, processes and procedures
- choice of transport companies
- securing the chain of supply (including developing and securing deliveries of materials for production )

## Total Productive Maintenance (TPM)

- Choice and verification of companies and/or employees responsible for maintenance (production lines, installations, tool shop, choice of solutions)
- Preventive maintenance
- Predictive maintenance

## Analysis and verification of manufacturing technology

- verification whether the adopted technological and process solutions are optimal and properly matched to the customer's needs
- looking for alternative technological solutions in terms of cost and quality

## Energy audits

- Energy quality audit
- Improving Energy Efficiency
- Energy Efficiency Audit
- Lighting audit
- Compressed air audit
- Audit of production technology
- Audit of heat nodes
- Enterprise energy audit

## Analysis and optimization of production and/or management processes

- 2D and 3D visualization and simulations of production processes
- Optimizations and improvements



[RETURN](#)





## Technical analyses and opinions

- Analysis of New Approach directives and related norms harmonised in terms of CE marking of products
- Product analysis and assignment according to given legal requirements of various types (directives, type approval, CE, regulations, marking identifying the producer/supplier of the destination vehicle)
- Analysis of other legal requirements (e.g. GVO directives)
- Technical analysis regarding vehicles and their components
- Electrical and electronic analysis for automotive vehicles
- Carrying out activities related to the verification of the declaration of conformity of automotive parts with the standards and technical conditions
- Agreements with institutions authorised for certification of the technical conditions and selection of representative samples of the parts subject to certification
- Analysis of test results and completion of documents for the Certification Body
- Transfer of full documentation to the Certification Body on behalf of the customer

## Verifications of the conformity of vehicle production with the producer's requirements

Within our range of services we offer:

- Work in the range of confirmation of conformity of vehicle construction with the requirements of the manufacturer of the base vehicle
- Certification inspections for firms assembling vehicles, on the order of base vehicle manufacturers (for Fiat Professional and Iveco, among others)
- Opinions on the conformity of vehicle construction with the Handbook of vehicle adaptations and construction publication.

## Opinions on innovativeness

BOSMAL is a research and development centre according to the definition from the Act of 30th May 2008 on certain forms of support for innovative activities (consolidated text from the Polish Legal Journal Dziennik Ustaw, 2015, item 1710, with later amendments), taking into account the provisions of the Act of April 30, 2010 – provisions introducing laws reforming the science system (Polish Legal Journal Dziennik Ustaw, No. 96, item 620, with later amendments).

In connection with the above, the Institute is able to offer in its scope of activities the elaboration of objective opinions on innovation for the needs of planned investments with the support of EU Operational Programs, based on the independent evaluations of our experts.

BOSMAL elaborates:

- opinions on product innovation,
- opinions on process innovation,
- opinions on technological innovations,
- opinions on non-technological innovations.

## Root cause analysis (RCA) of non-conformances of components and subassemblies

As part of our services, we offer:

- Work in the field of first and second degree technical analysis; reasons for the occurrence of simple damage; functional defects and electrical/electronic defects
- Examination of damaged parts/subassemblies in the scope of the defects detected
- Preparation of reports on the fault analysis
- Meetings with suppliers regarding the introduction of remedial procedures following the technical analysis

## Trainings on type-approval regulations and requirements

The training is addressed to manufacturers and distributors of vehicles and trailers and their items of equipment or parts, as well as to car services, vehicle inspection stations, vehicle bodybuilders, companies involved in the modernization of installations in vehicles, tuning of vehicles or construction of "SAM" vehicles. .

## Workshops on selected tests of materials and products



[RETURN](#)



### PCBC Certificate AQAP 2110:2016 NATO requirements for quality assurance in design, development and manufacture No. A-73/1/2021

System in the following scope of activities: **research, laboratory testing, development and implementation, engineering services, technical consulting, training, design, development, manufacture, distribution and service in the field of transport and their equipment** is in conformance with the standard **AQAP 2110:2016**

Certificate AQAP 2110:2016 PCBC Nr A-73/1/2021 is valid from 10.08.2021 do 09.08.2024. From September 10, 2021, a certification unit changed from CCJ to PCBC. Previous certificates: since 26.10.2015 - Certificate AQAP 2110:2009 CCJ WAT Nr 1124/A/2015, and since 10.08.2018 – Certificate AQAP 2110:2016 CCJ WAT Nr 1124/A/2018.



### PCA Accreditation Certificate of Testing Laboratory No. AB 128 BOSMAL laboratory meets requirements of the PN-EN ISO/IEC 17025:2018-02 standard. Accredited activities are defined in **the Scope of Accreditation No. AB 128**



AB 128



### TDT Certificate of Approval No. 4 022 2010 L

This is to confirm that Testing Laboratory fulfilling the criteria of the standard PN-EN ISO/IEC 17025:2018-02 granted approval on conducting tests a range listed enclosure for: certification body TDT-CERT



4 022 2010 L



[RETURN](#)





### PCBC Certificate No. JBS-199/4/2021

System in the following scope of activities:  
**design, testing and production of components for vehicles and their equipment, as well as test station and equipment for research and production** is in conformance with  
**PN-EN ISO 9001:2015-10, PN-ISO 45001:2018-06 and PN-EN ISO 14001:2015-09**



### IQNet Certificate of Integrated Management System No. PL-JBS – 199/4/2021

In the following scope of activities:  
**design, testing and production of components for vehicles and their equipment, as well as test station and equipment for research and production** system fulfills the requirements of the following standards:  
**PN-EN ISO 9001:2015-10, PN-ISO 45001:2018-06 and PN-EN ISO 14001:2015-09**



### TISAX label

Assessment of the BOSMAL for compliance with the **VDA-ISA** requirements, which includes the key security features of **ISO 27001** standard and additional criteria that relate to the automotive sector. The results of the assessment are available on the ENX platform:  
<https://portal.enx.com/en-US/TISAX/tisaxassessmentresults>



SCOPE-ID: ST38TZ  
<https://enx.com/tisax>





# CUSTOMERS' RECOMMENDATIONS AND ACCREDITATIONS

## Recommendation of Stellantis:



- for BOSMAL's tests in range of qualitative qualification of parts and assemblies to final assembly in Fiat manufacturing plants in Poland



**Acceptance of Volvo Car Corporation** for BOSMAL interior emission tests (formaldehyde acc. to VCS 1027,2739 and fogging acc. to VCS 1027,2719)



**Accreditation of Swiss Federal Office for the Environment (FOEN)** for BOSMAL as testing laboratory for tests according to the Swiss Federal Ordinance on Air Pollution Control (OAPC)



- for BOSMAL to carry out certain laboratory test work for Opel Plants



**BOSMAL LABORATORY APPROVAL FROM VOLKSWAGEN GROUP** - BOSMAL certified to perform material testing for Volkswagen Group suppliers with the negative Material Sampling Performance as per VW 52000 Standard. List of laboratories certified by the VW Group - on Volkswagen Group platform: [ONE.Konzern Business Plattform \(ONE.KBP\)](#)

**Acceptance of VOLKSWAGEN Group** for BOSMAL laboratory for emission tests required by VW 50180: standards PV3015 (fogging), PV3341 (VOC, headspace), PV3925 (formaldehyde, UV/VIS or HPLC), PV3900 (odour) and PV3942 (VOC, chamber emission tests).

**Acceptance of BMW** for BOSMAL laboratory for emission tests required by standards: VDA270 (odour), VDA278 (VOC and FOG, thermodesorption), GS97014-2 (CARB-Test, CARB-Screening), AA-0061 (formaldehyde and acetaldehyde, HPLC)

**Award for the best supplier of the year 2018 in the Engineering Services category of "FCA EMEA AWARD 2018"**



## Certificate of Business Credibility

BOSMAL - awarded for the highest evaluation of company stability in 2018 according to Bisnode Polska sp. z o.o.



## Membership



Polish Cluster of Composite Technologies



Polish Scientific Society of Combustion Engines



Klub Polskich Laboratoriów Badawczych POLLAB



**PKN**  
(Polish Committee for Standardization)

[RETURN](#)





- **SCOPE OF ACCREDITATION OF THE TESTING LABORATORY NO. AB 128**
- **CERTIFICATES, RECOMMENDATIONS, AWARDS AND DISTINCTIONS**
- **CONTACT – [kam@bosmal.com.pl](mailto:kam@bosmal.com.pl), +48 33 8130 544, +48 33 8130 462**

## We welcome your business

- Rental of employees
- Auditors / experts outsourcing
- Individual design
- Special production
- Development and optimization of processes in the company
- Opinions, analyzes, trainings and workshops



AB 128



SCOPE-ID: ST38TZ  
<https://enx.com/tisax>



4 022 2010 L



**RETURN**



**SEE MORE**  
**WWW**

**THANK YOU FOR YOUR ATTENTION**





MATERIAL TESTING

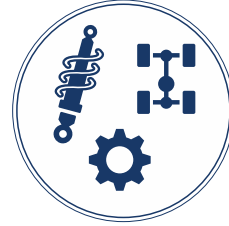

COMPONENT  
& ASSEMBLY TESTING



ROAD TESTING, EMISSION TESTING &  
ENGINE/POWERTRAIN TESTING

**BOSMAL**

**HOMOLOGATION  
TYPE APPROVAL**



PROTOTYPING, MANUFACTURING, ENGINEERING  
& PRODUCTION AUTOMATION



ENGINEERING  
SERVICES



**HOMOLOGATION  
TYPE APPROVAL**

[RETURN](#)

[SEE MORE](#)

[WWW](#)

50 years on the automotive market & 25 years as an Accredited Testing Laboratory AB 128



According to the decision No TD-5i-027-17(4)/13 of Polish Ministry of Transport, Construction and Maritime Economy of 14th October 2013, with amendments, BOSMAL Automotive Research and Development Institute Ltd is entitled to perform the following actions:

1. in the scope of approval:

- a) performing EC-type approval tests of vehicles or category **M, N, O, L, T, R, C** or **S** vehicle type approval tests,
- b) performing the approval tests of parts or equipment for category **M, N, O, L, T, R, C** or **S** vehicles,
- c) performing approval tests related to the installation process of gas retrofit systems adapting vehicles of category **M** or **N** to use gaseous fuels,
- d) performing:
  - Conformity of Production of vehicle, parts or equipment for category **M, N, O, L, T, R, C** or **S** vehicles,
  - Conformity of Production of installation of gas retrofit systems adapting vehicles of category **M** or **N** to use gaseous fuels;

2. within the scope of national individual vehicle approval, admission of a vehicle carrying out tests confirming the fulfilment of the applicable conditions or technical requirements of a given vehicle, in order to national individual vehicle approval for the categories of vehicles: **M, N** and **O**;

3) within the scope of individual vehicle approval, admission of a vehicle carrying out tests confirming the fulfilment of the applicable conditions or technical requirements of a given vehicle, in order to approve an individual vehicle for the categories of vehicles: **L, T, R** and **C**;

4) within the scope of EU individual vehicle approval, carrying out tests confirming the fulfilment of appropriate conditions or technical requirements of a given vehicle, for the purpose of EU approving of an individual vehicle for the categories of vehicles: **M1, N1** and **special vehicles M, N, and O**.

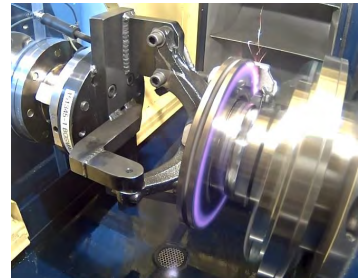

[RETURN](#)





# HOMOLOGATION, TYPE APPROVAL

## Scope of authorization to carry out type approval tests of the equipment or parts of category M, N, O, L, T, R, C or S vehicles according to the Decision of the Director of Transportation Technical Supervision No. H.840.56.2024.4.H of 26.04.2024 (short list):

- **for motor vehicles and their trailers (M, N, O):** 70/157/EEC, 70/221/EEC (A2), 70/222/EEC, 71/320/EEC, 76/114/EEC, 76/756/EEC, 76/757/EEC, 76/758/EEC, 76/759/EEC, 76/760/EEC, 77/538/EEC, 77/539/EEC, 77/540/EEC, 80/1269/EEC, 89/297/EEC, 91/226/EEC, 92/21/EEC, 92/22/EEC, 94/20/EC (A.V.1, A.V.2), 95/28/EC, 97/27/EC, 2001/85/EC, 2003/97/EC, 2005/55/EC, 2005/64/EC, 2006/40/EC, 715/2007, 692/2008, 595/2009, 672/2010, 1003/2010, 1005/2010, 1009/2010, 19/2011, 109/2011, 458/2011, 582/2011, 130/2012, 1230/2012, 540/2014, 2017/1151, 2017/1347, 2017/2400, 2021/535 (A. II, A. III, A. V, A. VI, A. VII, A. VIII, A. X, A. XI, A. XIII), 2022/1362.
- **for agricultural and forestry vehicles (T, R, C, S):** 76/432/EEC, 2009/60/EC (A1.1, A1.2), 2009/144/EC (A1, A2, A3 exc. A3 p.8.1.3.3), 1322/2014, (A. XVII, A.XXII, A.XXIV, A. XXV, A. XXVI), 2015/68, 2015/208 (A. II, A.XI, A. XII, A. XIV, A. XVIII, A. XIX, A. XX, A. XXI, A. XXII, A. XXIV and A. XXV, A. XXVI, A. XXVII, A. XXX, A.XXXI, A. XXXIV), 2016/1628, 2018/985.
- **for two- or three-wheel vehicles and quadricycles (L):** 3/2014 (A. IV), 134/2014
- **for vehicles in categories M, N, O, L and T according to UN Regulations No:** 1, 3, 4, 5, 6, 7, 8, 10 (A10), 11, 13, 13H, 14, 18, 19, 20, 23, 24, 26, 27 (exc. A5 p. 10), 28, 31, 37, 38, 39, 43 (exc. A3 p.: 3.2, 6.1-6.3), 46 (exc. p. 6.2 and A10), 48, 49, 50, 51, 53, 55, 56, 57, 58, 59, 61, 65, 67 (part II), 68, 69, 70, 72, 73, 74, 77, 78, 79, 82, 83, 84, 85, 86, 87, 89, 90, 91, 93, 96, 97, 98, 99, 100, 101, 102 (S.I.5, S.II.13), 103, 104, 105, 107, 110 (part II), 112, 113, 115, 116, 118, 119, 120, 123, 128, 132, 133, 136, 141, 142, 143, 145, 147, 148, 149, 150, 154.

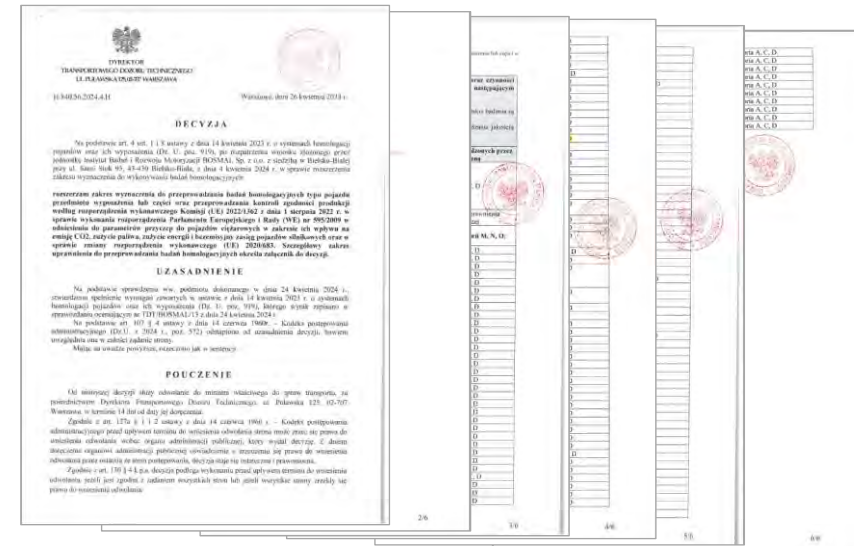
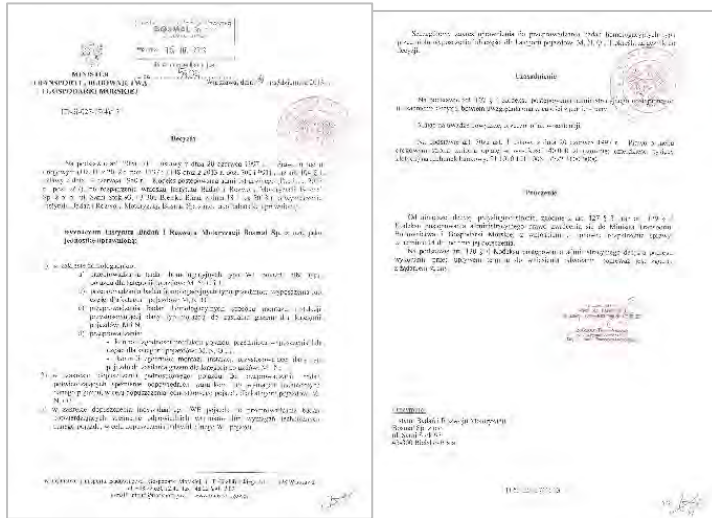

**RETURN**



# HOMOLOGATION, TYPE APPROVAL

Detailed scope of authorization to carry out type approval tests of the equipment or parts of category M, N, O, L, T, R, C or S vehicles according to the Decision of the Director of Transportation Technical Supervision No. H.840.56.2024.4.H of 26.04.2024:

## For motor vehicles and their trailers (M,N,O):

- 70/157/EEC Permissible sound level
- 70/221/EEC (A2) Rear protective devices
- 70/222/EEC Rear registration plate space
- 71/320/EEC Braking
- 76/114/EEC Statutory plates
- 76/756/EEC Installation of lighting and light signaling devices
- 76/757/EEC Retro reflectors
- 76/758/EEC End-outline, front-position (side), rear-position (side), stop, side marker, daytime running lamps
- 76/759/EEC Direction indicators
- 76/760/EEC Rear registration plate lamps
- 77/538/EEC Rear fog lamps
- 77/539/EEC Reversing lamps
- 77/540/EEC Parking lamps
- 80/1269/EEC Measurement of engine power
- 89/297/EEC Lateral protection
- 91/226/EEC Spray suppression systems
- 92/21/EEC Masses and dimensions (vehicles of category M1)
- 92/22/EEC Safety glazing
- 94/20/EC (A.V.1, A.V.2) Couplings (COUPLING BALLS AND TOWING BRACKETS, COUPLING HEADS
- 95/28/EC Flammability
- 97/27/EC Masses and dimensions (vehicles of category other than M1)
- 2001/85/EC Buses and coaches
- 2003/97/EC Indirect vision device
- 2005/55/EC Emissions (Euro IV and V) heavy duty vehicles
- 2005/64/EC Recycling
- 2006/40/EC Air-conditioning systems
- 715/2007 Emissions (Euro 5 and 6) light duty vehicles/ access to information
- 692/2008 Emissions (Euro 5 and 6) light duty vehicles/ access to information
- 595/2009 Emissions (Euro VI) heavy duty vehicles/ access to information
- 672/2010 Windscreen defrosting and demisting systems
- 1003/2010 Space for mounting and fixing rear registration plates
- 1005/2010 Towing device
- 1009/2010 Wheel guards
- 19/2011 Manufacturer's statutory plate and vehicle identification number
- 109/2011 Spray suppression systems
- 458/2011 Installation of tyres
- 582/2011 Emissions (Euro VI) heavy duty vehicles/ access to information
- 130/2012 Vehicle access and manoeuvrability
- 1230/2012 Masses and dimensions
- 540/2014 Sound level
- 2017/1151 Emissions (Euro 5 and 6) light duty vehicles/ access to information
- 2017/1347 Emissions (Euro 5 and 6) light duty vehicles/ access to information
- 2017/2400 Emissions (Euro VI) heavy duty vehicles/ access to information

- 2021/535 Statutory plate and the vehicle identification number (A. II), Space for mounting and fixing of front and rear registration plates (A. III), Wheel guards (A. V), Windscreen defrosting and demisting systems (A. VI), Towing devices (A. VII), Spray suppression systems (A. VIII), Vehicle access (A. X), Reversing motion (A. XI), Masses and dimensions (A. XIII)
- 2022/1362 Determination of specific energy efficiency performance of trailer

## For agricultural and forestry tractors (T, R, C, S):

- 76/432/EEC Breaking devices
- 2009/60/EC maximum design speed of and load platforms (A1.1 maximum design speed, A1.2 load platforms)
- 2009/144/EC Certain components and characteristics (A1 Dimensions and towable masses, A2 Speed governor and protection of drive components, projections and wheels, A3 Windscreen and other glazing Equipment (exc A3 p.8.1.3.3 Resistance-to-radiation test))
- 1322/2014 Protection of drive components (A. XVII), Operators manual (A. XXII), Protection against mechanical hazards (A. XXIV), Guards and protective devices (A. XXV) and Information, warnings and markings (A. XXVI)
- 2015/68 Braking devices and trailer brake coupling
- 2015/208 Vehicle structure integrity (A. II), Lighting, light signalling devices and their light sources (A. XI), Lighting installation (A. XII), Vehicle exterior and accessories (A. XIV), Devices to prevent unauthorised use (A. XVIII), Registration plate and marking (A. XX), Dimensions and trailer mass (A. XXI), Maximum laden mass (A. XXII), Safety of electrical systems (A. XXIV and XXV), Rear protective structures (A. XXVI), Lateral protection (A. XXVII), Tyres (A. XXX), Spray-suppression systems (A. XXXI) and Mechanical couplings (A. XXXIV)
- 2016/1628 Gaseous and particulate pollutant emission limits for internal combustion engines for non-road mobile machinery
- 2018/985 Environmental and propulsion unit performance requirements for agricultural and forestry vehicles and their engines

## For two- or three-wheel vehicles and quadricycles (L):

- 3/2014 Electrical safety (A.IV)
- 134/2014 Environmental and propulsion unit performance

## For vehicles in categories: M, N, O, L, T, R, S and C according to UN Regulations:

- No 1 Asymmetric headlamps (R2 and/or HS1)
- No 3 Retro-reflecting devices for power-driven vehicles and their trailers
- No 4 Illumination of rear-registration plates of power-driven vehicles and their trailers
- No 5 Asymmetric headlamps (Sealed Beam)
- No 6 Direction indicators for power-driven vehicles and their trailers
- No 7 Front and rear position lamps, stop-lamps and end-outline marker lamps for motor vehicles and their trailers
- No 8 Headlamps (H1, H2, H3, HB3, HB4, H7, H8, H9, HIR1, HIR2 and/or H11)
- No 10 (A10) Electromagnetic compatibility (Testing for immunity to and emission of transients of electrical/electronic sub-assemblies)
- No 11 Door latches and hinges
- No 13 Braking of vehicles and trailers
- No 13H Braking of passenger cars
- No 14 Safety-belt anchorages, ISOFIX anchorages systems, ISOFIX top tether anchorages and i-Size seating positions
- No 18 Anti-theft
- No 19 Front fog lamps of power-driven vehicle
- No 20 Asymmetric headlamps (R2 and/or HS1)
- No 23 Reversing lights for power-driven vehicles and their trailers
- No 24 Visible pollutants, measurement of power of C.I. engines (Diesel smoke)
- No 26 External projections
- No 27 (exc. A5 p.10) Advance warning triangles exc. Test of stability against wind
- No 28 Audible warning devices and audible signals
- No 31 Asymmetric headlamps (halogen sealed beam)
- No 37 Filament lamps
- No 38 Rear fog lamps for power-driven vehicles and their trailers
- No 39 Speedometer equipment including its installation
- No 43 (exc. A3 p.: 3.2, 6.1-6.3) Safety glazing materials and their installation on vehicles exc. Headform test with deceleration measurement, Resistance-to-radiation test
- No 46 (exc. p.6.2 and A10) Devices for indirect vision and their installation exc. Devices for indirect vision other than mirrors, Calculation of the detection distance for CMS of Classes V and VI

**RETURN**

50 years on the automotive market & 25 years as an Accredited Testing Laboratory AB 128





# HOMOLOGATION, TYPE APPROVAL

Detailed scope of authorization to carry out type approval tests of the equipment or parts of category M, N, O, L, T, R, C or S vehicles according to the Decision of the Director of Transportation Technical Supervision No. H.840.56.2024.4.H of 26.04.2024:

## For vehicles in categories: M, N, O, L, T, R, S and C according to UN Regulations:

- No 48 Installation of lighting and light-signaling devices on motor vehicles
- No 49 Measures to against the emission of gaseous and particulate pollutants
- No 50 Front/rear position lamps, stop lamps, direction indicators, rear registration plate lamps (vehicle cat. L)
- No 51 Noise emissions
- No 53 Installation of lighting and light-signalling devices
- No 55 Mechanical coupling components of combinations of vehicles
- No 56 Headlamps for mopeds
- No 57 Headlamps for motorcycles
- No 58 Rear underrun protective devices (RUPDs) and their installation; rear underrun protection (RUP)
- No 59 Replacement silencing systems
- No 61 Commercial vehicles with regard to their external projections forward of the cab's rear panel
- No 65 Special warning lamps
- No 67 Specific components for liquefied petroleum gases (LPG) and their installation on motor vehicles (part II)
- No 68 Measurement of the maximum speed, including electric vehicles
- No 69 Rear marking plates for slow-moving vehicles
- No 70 Rear marking plates for heavy and long vehicles
- No 72 Headlamps for motorcycles (HS1)
- No 73 Lateral protection of goods vehicles
- No 74 Installation of lighting and light-signalling devices
- No 77 Parking lamps for power-driven vehicles
- No 78 Braking
- No.79 Steering equipment
- No 82 Headlamps for mopeds (HS2)
- No 83 Emissions of M1 and N1 vehicles
- No 84 Fuel consumption
- No 85 Measurement of the net power and the 30 min. power
- No 86 Installation of lighting and light-signalling devices
- No 87 Daytime running lamps for power-driven vehicles
- No 89 Speed limitation devices
- No 90 Replacement braking parts
- No 91 Side-marker lamps for motor vehicles and their trailers
- No 93 Front underrun protective devices
- No 96 Diesel emission (agricultural tractors)
- No 97 Alarm systems
- No 98 Headlamps with gas-discharge light sources
- No 99 Gas-discharge light sources
- No 100 Battery electric vehicles safety
- No 101 CO<sub>2</sub> emission/fuel consumption
- No 102 (S.I.5, S.II.13) Close-coupling device (CCD); fitting of an approved type of CCD - Specifications, Requirements concerning the fitting of an approved CCD
- No 103 Replacement pollution control devices
- No 104 Retro-reflective markings
- No 105 Carriage of dangerous goods
- No 107 M2 and M3 vehicles
- No 110 Specific components for CNG and their installation on motor vehicles (part II)
- No 112 Headlamps equipped with filament lamps and/or light-emitting diode LED modules
- No 113 Headlamps equipped with filament, gas-discharge light sources or LED modules
- No 115 LPG and CNG retrofit systems
- No 116 Anti-theft and alarm systems
- No 118 Burning behaviour of materials used in the interior construction of certain categories of motor vehicles
- No 119 Cornering lamps
- No 120 Internal combustion engines for agricultural and forestry tractors and non-road mobile machinery (net power, net torque and specific fuel consumption)
- No 123 Adaptive front-lighting systems (AFS) for motor vehicles
- No 128 Light Emitting Diode (LED) light sources
- No 132 Retrofit Emission Control Devices (REC) for heavy duty vehicles, agricultural and forestry tractors and non-road mobile machinery
- No 133 Recyclability of motor vehicles
- No 136 Electric vehicles of category L
- No 141 Tyre pressure monitoring system (TPMS)
- No 142 Tyre installation
- No 143 Heavy Duty Dual-Fuel Engine Retrofit Systems (HDDF-ERS)
- No 145 ISOFIX anchorage systems, ISOFIX top tether anchorages and i-Size seating positions
- No 147 Mechanical coupling components of combinations of agricultural vehicles
- No 148 Light Signalling Devices (LSD)
- No 149 Road Illumination Devices (RID)
- No 150 Retro-Reflective Devices (RRD)
- No 154 Emissions of carbon dioxide and fuel consumption, the measurement of electric energy consumption and electric range (WLTP)



[RETURN](#)



### PCBC Certificate AQAP 2110:2016 NATO requirements for quality assurance in design, development and manufacture No. A-73/1/2021

System in the following scope of activities: **research, laboratory testing, development and implementation, engineering services, technical consulting, training, design, development, manufacture, distribution and service in the field of transport and their equipment** is in conformance with the standard **AQAP 2110:2016**

Certificate AQAP 2110:2016 PCBC Nr A-73/1/2021 is valid from 10.08.2021 do 09.08.2024. From September 10, 2021, a certification unit changed from CCJ to PCBC. Previous certificates: since 26.10.2015 - Certificate AQAP 2110:2009 CCJ WAT Nr 1124/A/2015, and since 10.08.2018 – Certificate AQAP 2110:2016 CCJ WAT Nr 1124/A/2018.



### PCA Accreditation Certificate of Testing Laboratory No. AB 128 BOSMAL laboratory meets requirements of the PN-EN ISO/IEC 17025:2018-02 standard. Accredited activities are defined in **the Scope of Accreditation No. AB 128**



AB 128



### TDT Certificate of Approval No. 4 022 2010 L

This is to confirm that Testing Laboratory fulfilling the criteria of the standard PN-EN ISO/IEC 17025:2018-02 granted approval on conducting tests a range listed enclosure for: certification body TDT-CERT



4 022 2010 L



[RETURN](#)





### PCBC Certificate No. JBS-199/4/2021

System in the following scope of activities:  
**design, testing and production of components for vehicles and their equipment, as well as test station and equipment for research and production** is in conformance with  
**PN-EN ISO 9001:2015-10, PN-ISO 45001:2018-06 and PN-EN ISO 14001:2015-09**



### IQNet Certificate of Integrated Management System No. PL-JBS – 199/4/2021

In the following scope of activities:  
**design, testing and production of components for vehicles and their equipment, as well as test station and equipment for research and production** system fulfills the requirements of the following standards:  
**PN-EN ISO 9001:2015-10, PN-ISO 45001:2018-06 and PN-EN ISO 14001:2015-09**



### TISAX label

Assessment of the BOSMAL for compliance with the **VDA-ISA** requirements, which includes the key security features of **ISO 27001** standard and additional criteria that relate to the automotive sector. The results of the assessment are available on the ENX platform:  
<https://portal.enx.com/en-US/TISAX/tisaxassessmentresults>



SCOPE-ID: ST38TZ  
<https://enx.com/tisax>





# CUSTOMERS' RECOMMENDATIONS AND ACCREDITATIONS

## Recommendation of Stellantis:



- for BOSMAL's tests in range of qualitative qualification of parts and assemblies to final assembly in Fiat manufacturing plants in Poland



**Acceptance of Volvo Car Corporation** for BOSMAL interior emission tests (formaldehyde acc. to VCS 1027,2739 and fogging acc. to VCS 1027,2719)



**Accreditation of Swiss Federal Office for the Environment (FOEN)** for BOSMAL as testing laboratory for tests according to the Swiss Federal Ordinance on Air Pollution Control (OAPC)



- for BOSMAL to carry out certain laboratory test work for Opel Plants



**BOSMAL LABORATORY APPROVAL FROM VOLKSWAGEN GROUP** - BOSMAL certified to perform material testing for Volkswagen Group suppliers with the negative Material Sampling Performance as per VW 52000 Standard. List of laboratories certified by the VW Group - on Volkswagen Group platform: [ONE.Konzern Business Plattform \(ONE.KBP\)](#)

**Acceptance of VOLKSWAGEN Group** for BOSMAL laboratory for emission tests required by VW 50180: standards PV3015 (fogging), PV3341 (VOC, headspace), PV3925 (formaldehyde, UV/VIS or HPLC), PV3900 (odour) and PV3942 (VOC, chamber emission tests).

**Acceptance of BMW** for BOSMAL laboratory for emission tests required by standards: VDA270 (odour), VDA278 (VOC and FOG, thermodesorption), GS97014-2 (CARB-Test, CARB-Screening), AA-0061 (formaldehyde and acetaldehyde, HPLC)

**Award for the best supplier of the year 2018 in the Engineering Services category of "FCA EMEA AWARD 2018"**



## Certificate of Business Credibility

BOSMAL - awarded for the highest evaluation of company stability in 2018 according to Bisnode Polska sp. z o.o.



## Membership



Polish Cluster of Composite Technologies



Polish Scientific Society of Combustion Engines



Klub Polskich Laboratoriów Badawczych POLLAB



**PKN**  
(Polish Committee for Standardization)

[RETURN](#)





- SCOPE OF ACCREDITATION OF THE TESTING LABORATORY NO. AB 128
- CERTIFICATES, RECOMMENDATIONS, AWARDS AND DISTINCTIONS
- CONTACT – [kam@bosmal.com.pl](mailto:kam@bosmal.com.pl), +48 33 8130 544, +48 33 8130 462



AB 128



SCOPE-ID: ST38TZ  
<https://enx.com/tisax>



4 022 2010 L

## We welcome your business



RETURN

50 years on the automotive market & 25 years as an Accredited Testing Laboratory AB 128



SEE MORE  
WWW

**THANK YOU FOR YOUR ATTENTION**